

ABUTMENTS
CATALOGUE
2022

THE BEGINNING OF
LOTS OF SMILES





IBO is a consolidated company, created by professionals in the dental sector aiming to offer our customers the most innovative solutions in the field of abutments for dental implants.

Our team of engineers works under the advice of renowned professionals of the dental sector. This allows **IBO** to be at the forefront in design and manufacturing in all our products.

With presence in more than 25 countries, we are committed to the future, quality and satisfaction of all our customers.

Lifetime warranty.

www.ibodontit.com



ABUTMENTS MANUFACTURING

Our abutments are manufactured with the highest technology and latest novelties in the CNC machining sector and using state-of-the-art machinery.

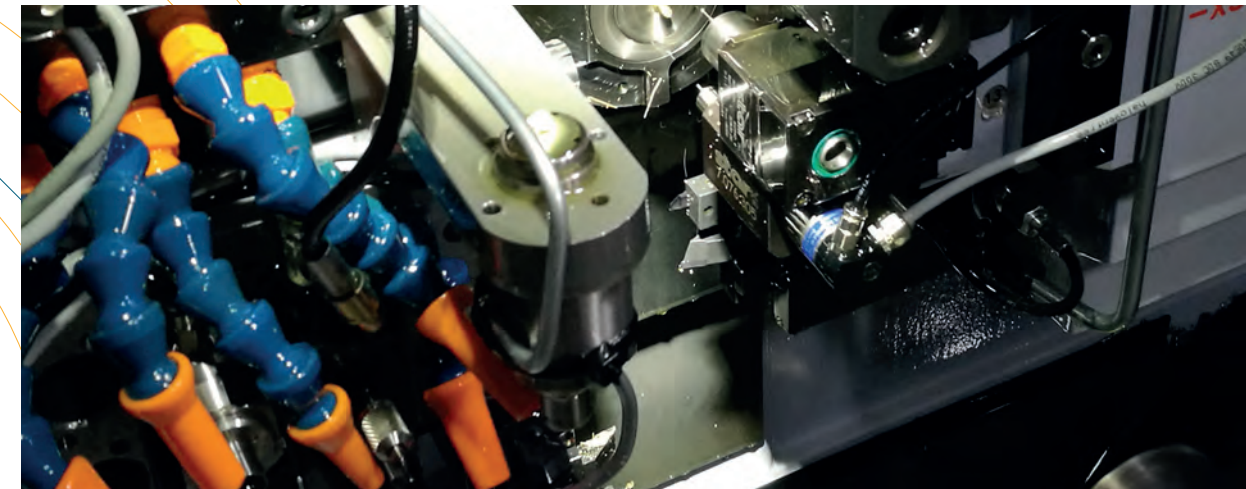
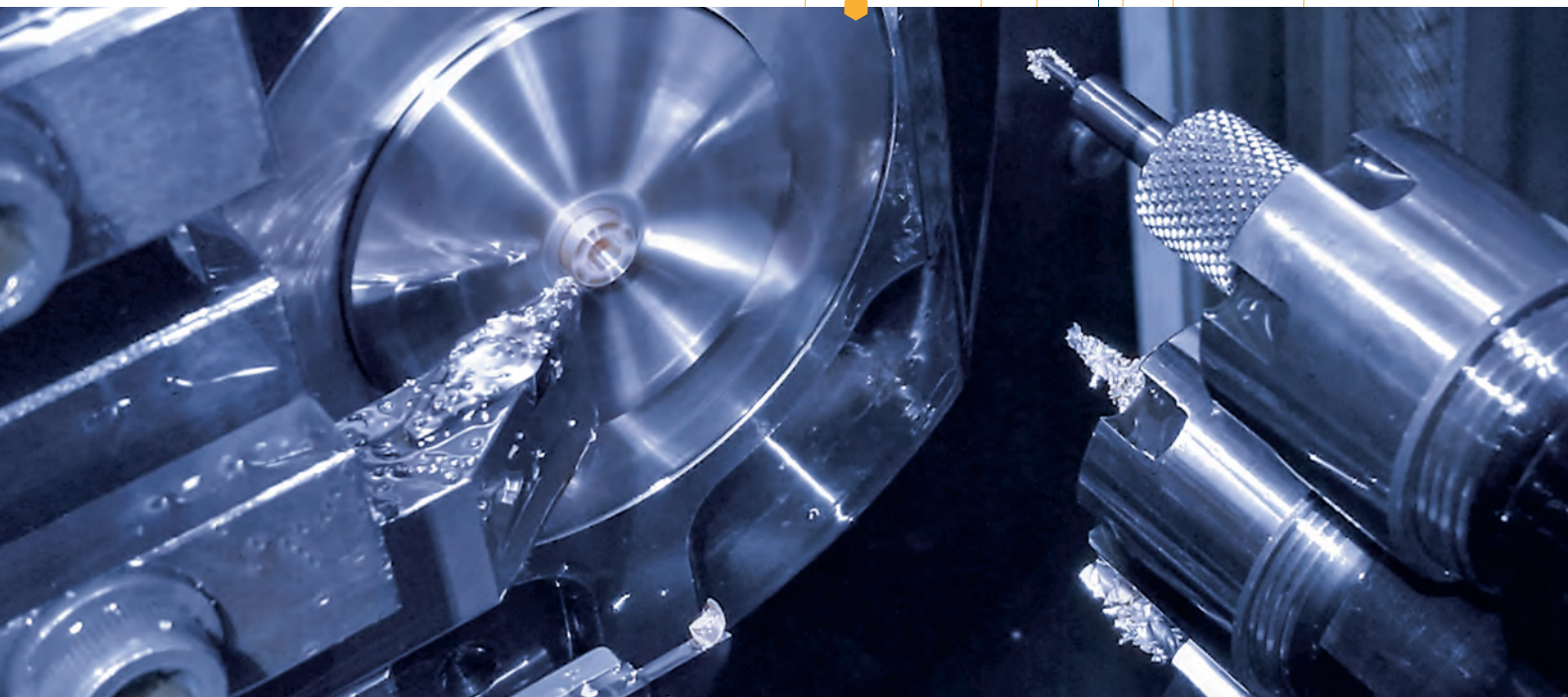

CUSTOMIZED ABUTMENTS

We manufacture customized abutments to fulfil special needs of our customers. We handle the design and manufacturing of the abutment that you need for your work.

Our engineers will work side by side with you in the design of your abutment to ensure that it meets your parameters and covers your needs.

Ask us, we will study the connection you need and we will develop a project accordingly to your requirements.

QUALITY

At IBO we have the following quality certificates that guarantee our effort in maintaining perfection in our products:

- ISO13485:2016: Quality management systems in medical device manufacture.
- CE marking in all our products.
- AEMPS (Agencia Española de Medicamentos y Productos Sanitarios) license.

The work protocol of our quality department is based in an exhaustive visual control of all our devices. This is followed by a thorough functional and dimensional control, in which the critical dimensions of each piece are evaluated to ensure the optimal functioning of our abutments.



WARRANTY

Our commitment with you is to offer the highest quality in our products.

We ensure that we always work with materials and surface treatments of the highest qualities.

We take over design, development and manufacturing processes of all our devices until they are placed in the market to offer the best product to the implantologist and/or prosthetic professionals.

We are so convinced of the quality of our devices that our products have a **lifetime warranty**.

AC SCREW SYSTEM

Working on angled channel system allows solving the most difficult cases in screw-retained prostheses. This system ensures excellent aesthetics and functioning of the prosthesis.

The combination of our ACS screw with CAD libraries and CoCr abutments + angled chimneys (17° and 30°) allows the modification of the screw channel angulation. Thus, making possible screw-retained restorations that were not possible until now.

PRACTICALITY

- Tetra-lobular geometry exclusivity.
- Impossibility of fitting with any other 4-spline wrench.
- Quick visual identification in any clinical situation.

KINEMATICS

- Perfect fitting between screw and driver.
- Improves slippage and reduces the risk of accidental disengagement.

MECHANICS

- Wider and more robust grooves to reduce stripping risk.
Its high resistance builds confidence when applying the required torque.
- Increase of the tangential force vector to the rotation that helps threading and unscrewing movements.
- Possibility of an angulation of up to 30°. This angulation is usually enough to correct most of the cases.

Manufactured in grade 5 titanium for medical use and available for most of the implant systems in the market.

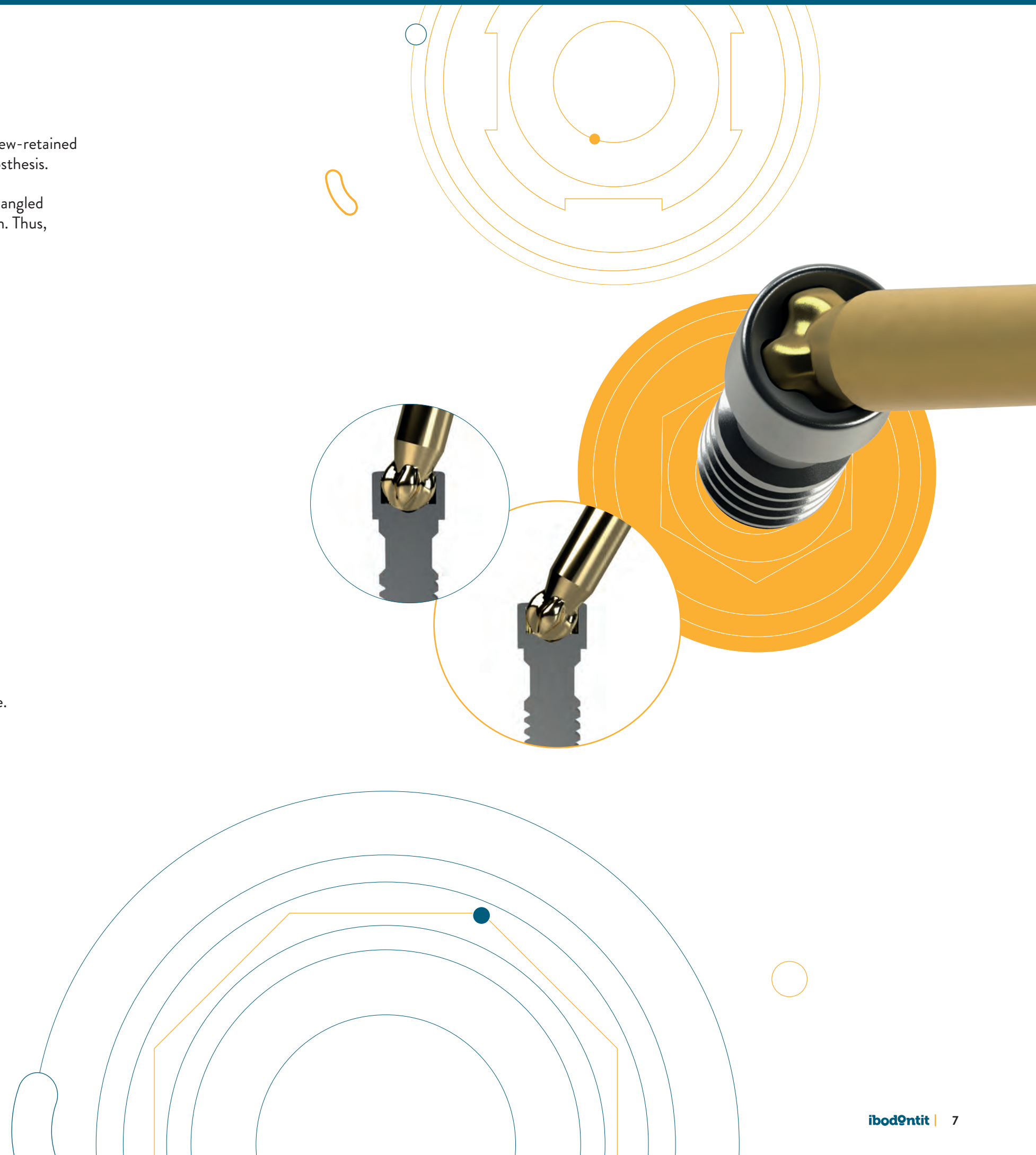

ANALOGUES

Analogues ready for any use: conventional and CAD/CAM digital flow.

Reduced length compared to conventional analogues to facilitate model creation in the clinic. In addition, its screw in the lower part allows fixing analogues in the printed model.

They also feature double groove and double flat face so they are totally immobilized in the plaster model.

Customized CAD libraries.

We customize our digital analogue library to meet the resolution of your 3D printing machine. Through a calibration pattern, you will be able to choose among 9 different combinations (tolerance variation) to work with your 3D printing machine in the best possible way.

- Perfect fit between milled and printed 3D models.
- Maximum precision of dimensional tolerances.
- Customized CAD/CAM library according to customer 3D printing machine.
- Fixation screw to the model.

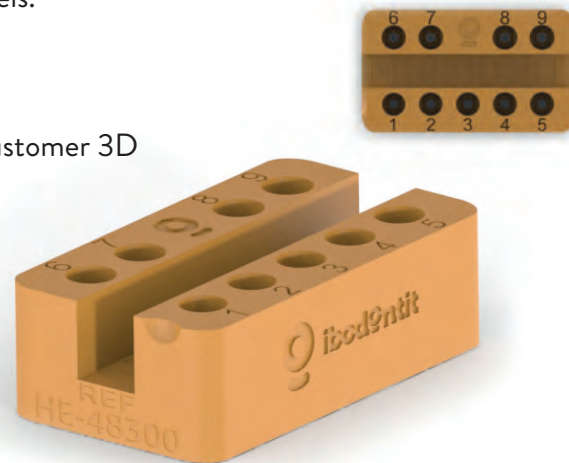

SCREW WITH PVD COATING

We present the evolution of the clinical screw. Screws with WC/C (tungsten carbide) coating increase their performance since they can reduce screw torque while improving a 30% the tightening torque. Thus, making a more stable fixation.

Recommended for cases of screw loosening.

PROPERTIES:

- Fully heme and biocompatible as it is carbon-based.
- Very resistant to corrosion.
- High wear resistance.
- High hardness (2.000-5.000 HV)
- Very low friction coefficient (0.1-0.01)
- Sterilizable.



ANGLED CHIMNEY

We have chimneys for our machined CoCr abutments with two different angulations: 17° and 30°.

Our chimneys are manufactured in 100% castable photopolymerizable resins. Thus, allowing a clean and exact casting.



CAD/CAM – IBO DIGITAL LIBRARIES

IBO digital libraries have been designed side by side with the main dental design software developers and offer a wide range of CAD/CAM possibilities.



Available for different works:

- Implant level (direct to implant milling or sintered + re-machining).
- Interfaces with different gingival and cementation heights.
- Machined CoCr abutments.
- Temporary abutments with different cementation heights.
- Digital analogues for 3D models.

All cases include the possibility of working with laboratory (Peek) or intraoral (titanium) scan bodies. They are also adapted to work both in straight or angled channels. All our libraries are certified and validated by CAM software developers.



We have a wide library catalogue, making possible the design of any kind of work: Direct to implant milling, sintered + re-machining, titanium or CoCr abutments.

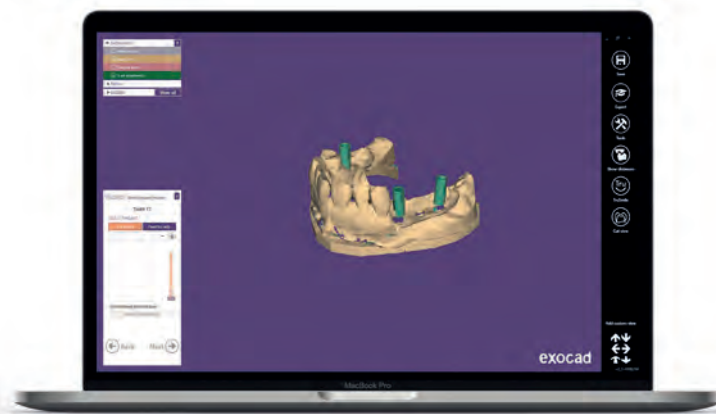

AC 2G TiBASE

Designed to correct angulations in combination with ACS angled screw. They feature a window to access the screw head to the maximum depth of screwing.

Their design allows suitable ceramics or zirconium thickness to obtain optimal functional results while avoiding system fatigue.

Conical design for multiple restorations and double flat face in vestibular and palatine.

Different gingival heights for the main implant systems to facilitate the adaptation in the gum.

Digital libraries available for all dental CAD softwares.



3G TiBASE

100% digital interface.

Specially conceived for model-free cementation.

Thanks to its innovative design, 3G interface makes easier the milling of the crown, providing an optimal fit.

Improves the sealing with the prosthesis ensuring a free-cement seat and a soft transition to the prosthesis.

Different gingival heights for the main implant systems to facilitate the adaptation to the gum.

Different cementation heights (7, 5 and 3 mm) in CAD libraries.

We have libraries with special options to maximize the benefits of 3D printing manufacturing.

Coating: TiN.

SCANBODY

- Laboratory scanbody: 5.5 mm diameter scanbody to increase cylindrical surface as well as surface of the two flat faces. This allows enhancing scan definition. These scanbodies are designed to work over conventional models perfectly.

Monoblock device manufactured entirely in Peek. Since it is manufactured in one piece, coupling divergencies between pieces are avoided.

- Intraoral scanbody: intraoral scanbodies have reduced height and diameter to facilitate its placement in the mouth. They also have a similar diameter to the connection. As it is a Monoblock device, it does not generate divergencies in its coupling.

Manufactured entirely in titanium, it allows its X-Ray visualization to verify its fitting. Intraoral scanbodies have a superficial treatment with zirconium nitride (ZrN). This provides a matte surface which facilitates scanning process, avoiding the use of sprays.

- Reduced length to facilitate its use in the mouth.
- They are visible under x-ray to check a correct fitting with the implant.
- Same diameter as the connection.
- Captive clamping screw.
- Made entirely of grade 5 titanium for medical use with Zirconium Nitride (ZrN) coating for perfect reading.

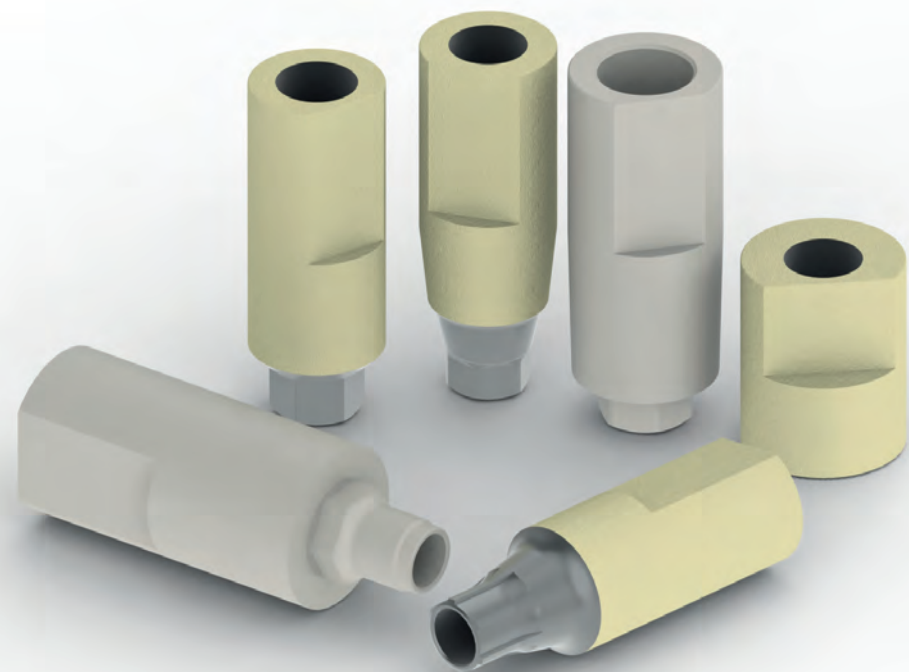

LOCK-ATTACH

The perfect solution for removable overdentures.

Lock-Attach abutment is superficially treated with Titanium Nitride (TiN). This coating provides wear resistance and prevents bacterial attack.

Different heights available for the correct adaptation to surrounding gingival tissue.

Each clinical case needs certain overdenture extraction effort. Therefore, there are different references with different degrees of retention force.

- Greater resistance to abrasive wear: up to 2400 vickers of hardness.
- Reduces friction coefficient.
- Higher fatigue resistance. Prevents gaps due to wear.
- Biocompatibility test, FDA, cytotoxicity test as well as irritation and sensitization tests approved.
- Barrier coating, which prevents ion leaching.
- Prevents organic debris adherence. Reduces bacterial activity.

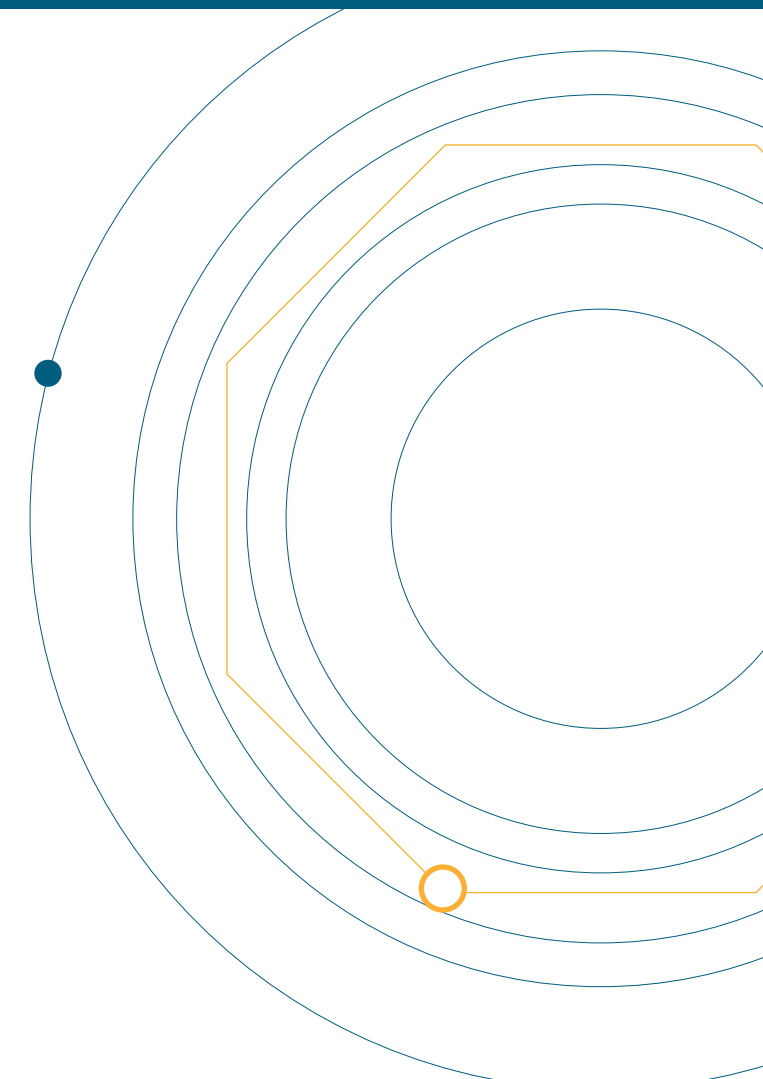

FLUJO MULTIUNIT					18 - 19
FLUJO LOCK-ATTACH					21 - 21
NOBEL BIOCARE®					
	HE	CAD/CAM 1100	BRANEMARK®	ø 3.5 / ø 4.1 / ø 5.1	24 - 27
	HEZ	CAD/CAM 1300	REPLACE®	ø 3.5 / ø 4.3 / ø 5.0	28 - 29
	HEC	CAD/CAM 1400	ACTIVE®	ø 3.0 / ø 3.5 / ø 4.3	30 - 33
ZIMMER®					
	HEI	CAD/CAM 1500	SCREW VENT®	ø 3.5 / ø 4.5 / ø 5.7	36 - 39
STRAUMANN®					
	HI	CAD/CAM 1800	TISSUE LEVEL®	ø 4.8 RN / ø 6.5 WN	42 - 45
	HI	CAD/CAM 1900	BONE LEVEL®	ø 3.3 NC / ø 4.1 RC	46 - 47
		CAD/CAM 3800	BLX®	RB / WB	48 - 49
ASTRA TECH®					
	HEA	CAD/CAM 2000	OSSEOSPEED Tx®	ø 3.0 / AQUA ø 3.5 - ø 4.0 LILAC ø 4.5 - ø 5.0	52 - 55
		CAD/CAM 3200	EV®	ø 3.0 / ø 3.6 / ø 4.2 / ø 4.8	56 - 57
BIOMET 3i®					
	HE	CAD/CAM 2100	EXTERNAL HEX.®	ø 3.25 / ø 4.1 / ø 5.0	60 - 63
	HEH	CAD/CAM 2200	CERTAIN®	ø 3.4 / ø 4.1 / ø 5.0	64 - 65
MIS®					
	HEM	CAD/CAM 1700	SEVEN®	ø 3.3 NP, SP, WP	68 - 71
		CAD/CAM 4000	C1/V3®	SP	72 - 73
SWEDEN & MARTINA®					
	HES	CAD/CAM 2700	PREMIUM KOHNO®	ø 3.3 / ø 3.8 / ø 4.25 / ø 5.0	76 - 77
KLOCKNER®					
	HEV	CAD/CAM 2300	SK2-NK2®	ø 4.2	80 - 81
	HEV	CAD/CAM 2400	ESSENTIAL®	ø 4.5	82 - 83
		CAD/CAM4100	VEGA®	ø 3.5 / ø 4.0 / ø 4.5	84 - 85
BIOHORIZONS®					
	HEI	CAD/CAM 1600	TAPERED INTERNAL®	ø 3.0 / ø 3.5 / ø 4.5	88 - 91

DENTSPLY®					
		CAD/CAM 3100	FRIADENT XIVE®	ø 3.4 / ø 3.8 / ø 4.5	94 - 95
		CAD/CAM 3500	ANKYLOS®	C/X	96 - 97
BTI®					
		CAD/CAM 2600	EXTERNAL HEX.®	ø 3.5 / ø 4.1	100 - 101
	HEB	CAD/CAM 2500	INTERNAL®	ø 4.1 UNIVERSAL / ø 5.5 ANCHA	102 - 103
MICRODENT®					
		CAD/CAM 3300	SYSTEM®	ø 4.2 / ø 5.1	106 - 107
PHIBO®					
	HPH	CAD/CAM 2900	TSH®	S2 / S3-S4	110 - 111
NEODENT®					
		CAD/CAM 3400	CM CONO MORSE®	ø 3.5	114 - 115
		CAD/CAM 3600	GM GRAND MORSE®	ø 3.5 / ø 3.75 / ø 4.0 / ø 4.3 / ø 5.0 / ø 6.0	116 - 117
OSSTEM®					
		CAD/CAM 3000	TS SYSTEM®	REGULAR	120 - 121
BEGO®					
		CAD/CAM 3900	SC/RS®	ø 3.25 / ø 3.75 / ø 4.1 / ø 4.5	124 - 125
MEGAGEN®					
		CAD/CAM 3700	ANYRIDGE®	ø 4.0	128 - 129
DRIVERS					132 - 133
INSTRUMENTS AND TOOLS					134 - 135
STRAIGHT ABUTMENT SCREWS					136 - 139
ANGLED ABUTMENT SCREWS					140 - 143

The abutments supplied by Ibdontit S.L. are compatible with different implant systems. These brands are listed purely for information purposes in order to identify those connections with which IBO abutments are compatible. The images shown in this catalogue have no contractual value.



Haliotis mollusk shell at zoom x70

WORKFLOWS

MULTIUNIT FLOW

RP Ø4.8

RP Ø4.8



Analogue

Non-Engaging	HE-48300
Engaging	HE-48310
Estheticone	HE-48350



Digital Analogue Screw

M1.6 w/hex. 1.20	HE-41215
------------------	----------



Impression Coping

Non-Engaging - Open Tray (OT)	HE-48700
Non-Engaging - Closed Tray (CT)	HE-48710
Engaging - Open Tray (OT)	HE-48703
Non-Engaging - Open Tray (OT) Estheticone	HE-48701
Impression Coping OT	HE-48702



Healing Cap

POM	HE-48620
Titanium (screw included)	HE-48621
Titanium (screw included) Estheticone	HE-48623



Screw

M1.4 Unigrip	HE-48200
M1.4 DLC Unigrip	HE-48280
M1.4 Gold Unigrip	HE-48206
M1.4 w/hex. 1.27	HE-48201

M1.4 ACS Four-Lobed	IBO 1201 225
---------------------	--------------



Castable

Non-Engaging	HE-48010
Non-Engaging Estheticone	HE-48050



CoCr Base Castable

Non-Engaging	HE-48100
Engaging	HE-48110



CoCr Base Angled Chimney

17°	IBO 1102 011
30°	IBO 1102 012



Temporary Abutment

Non-Engaging	HE-48610
Non-Engaging Peek	HE-48613
Non-Engaging Estheticone	HE-48611
Engaging	HE-48614
TiBase Non-Engaging	HE-48615
TiBase Engaging	HE-48616



Scanbody

Intraoral Titanium Non-Engaging	IBO 1201 702
Intraoral Titanium Engaging	IBO 1201 703
Laboratory Non-Engaging	HE-48770



1G TiBase

Non-Engaging	HE-48750
Engaging	HE-48751



AC 2G TiBase

Non-Engaging	IBO 1201 621
--------------	--------------



Lock-Attach Abutment

H 3mm	HE-48903
-------	----------

LOCK-ATTACH FLOW

MULTISYSTEM

MULTISYSTEM

	Analogue	
		HE-41911
	Impression Coping	
(4U) Pack		HE-41920
	Housing for Lock-Attach bar	
(4U) Pack		HE-41930
	Driver for Lock-Attach	
		HE-41912
	Prosthetic Kit	
		HE-41910
	Components	
	Retention Insert Blue 1.5 lbs (5U)	HE-41913
	Retention Insert Pink 3 lbs (5U)	HE-41914
	Retention Insert White 5 lbs (5U)	HE-41915
	Retention Insert Red 1.5 lbs (5U)	HE-41916
	Retention Insert Black Lab. (5U)	HE-41917
	Denture Insert Lock-Attach (5U)	HE-41918
	Black-out Spacer Lock-Attach (5U)	HE-41919
	Lock-Attach abutment for Bar	
M2		HE-41909

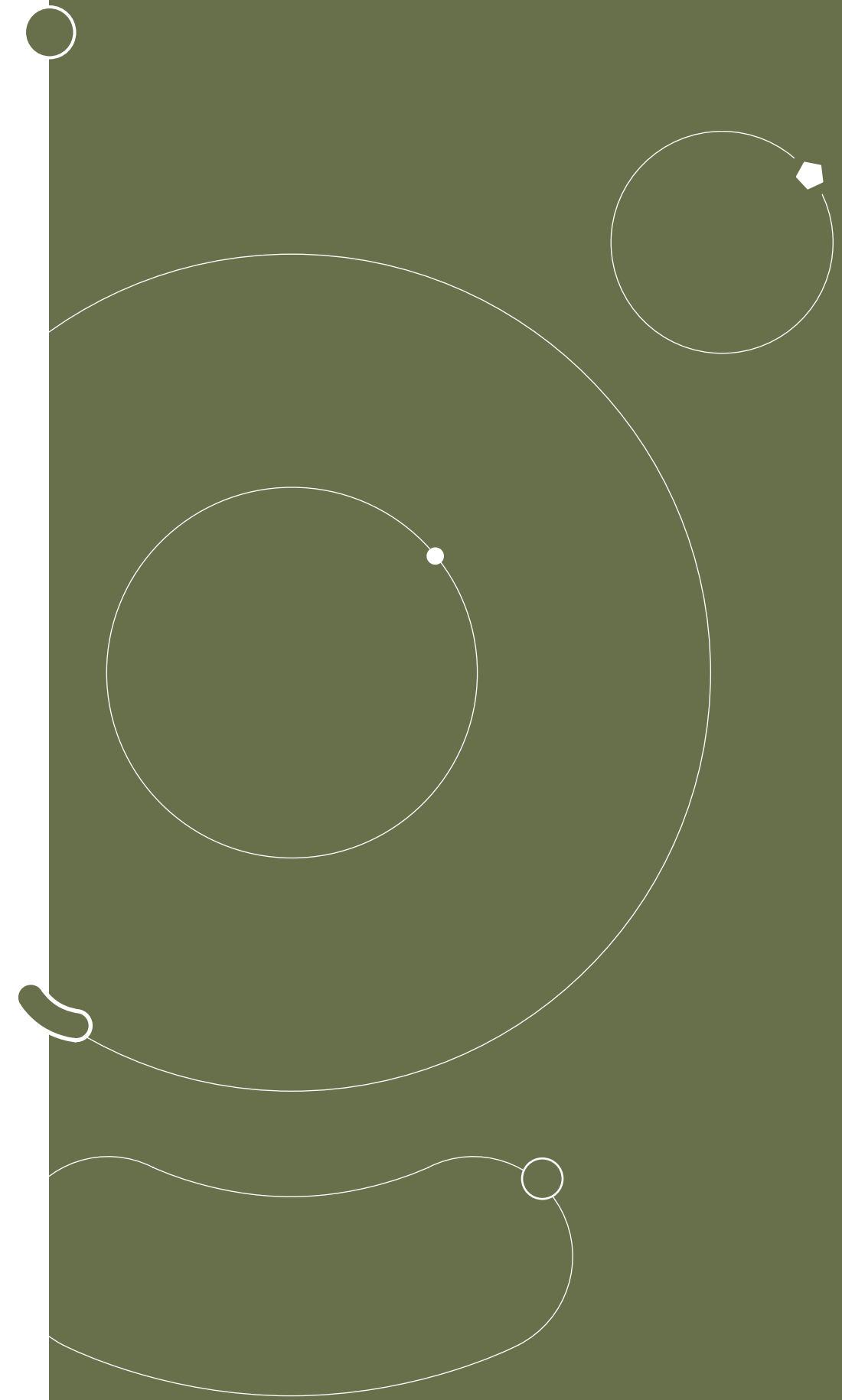

NOBEL BIOCARE®

HE CAD/CAM 1100
BRANEMARK®

HEZ CAD/CAM 1300
REPLACE®

HEC CAD/CAM 1400
ACTIVE®

Ibodontit S.L. has no connection with any of the brands listed above, which are the property of their respective trademark holders



Sand from Punta Matira beach
in Polynesia zoomed x200



NOBEL BIOCARE® BRANEMARK®

Ø3.5 / Ø4.1 / Ø5.1



	NP Ø3.5	RP Ø4.1	WP Ø5.1
Analogue			
	HE-35300	HE-41300	HE-51301
Digital Analogue Screw			
M1.6 w/hex. 1.20	HE-41215	HE-41215	HE-41215
Impression Coping			
Open Tray (OT)	HE-35700	HE-41700	HE-51702
Closed Tray (CT)		HE-41710	
Impression Coping OT		HE-41701	
Impression Coping CT		HE-41711	
Healing Cap			
H 2mm		HE-41402	
H 3mm	HE-35403	HE-41403	HE-51413
H 4mm		HE-41404	
H 5mm	HE-35405	HE-41405	HE-51415
Screw			
M1.6 w/hex. 1.20	HE-35200		
M1.6 w/hex. 1.20 DLC	HE-35280		
M2 w/hex. 1.20 DLC		HE-41200	
M2 w/hex. 1.20 DLC		HE-41280	
Flat Seat M2 w/hex. 1.20		HE-41201	
M2 Square 1.30		HE-41202	
M2 w/hex. 1.25		HE-41203	
M2 Flat w/hex. 1.20		HE-41204	
M2 Self-locking w/hex. 1.25		HE-41205	
M2 Goldgrip w/hex. 1.20		HE-41206	
M2 Unigrip		HE-41207	
M2 w/hex. 1.20 Fully Threaded		HE-41208	
Cover screw M2		HE-41210	
M2.5 Unigrip			HE-51200
M2.5 Unigrip DLC			HE-51280
M1.6 Four-Lobed ACS	IBO 1101 225		
M2 Four-Lobed ACS		IBO 1102 225	
M2.5 Four-Lobed ACS			IBO 1103 225

	NP Ø3.5	RP Ø4.1	WP Ø5.1
Castable			
Engaging	HE-35001	HE-41001	HE-51002
Non-Engaging	HE-35010	HE-41010	HE-51011
CoCr Base Castable			
Engaging	HE-35110	HE-41110	HE-51110
Non-Engaging	HE-35100	HE-41100	HE-51100
CoCr Base Angled Chimney			
17°	IBO 1102 011	IBO 1102 011	IBO 1101 013
30°	IBO 1102 012	IBO 1102 012	
Temporary Abutment			
Engaging	HE-35600	HE-41600	HE-51601
Non-Engaging	HE-35610	HE-41610	HE-51611
Straight / Angled Abutment			
Engaging	HE-35500	HE-41500	
Non-Engaging	HE-35550	HE-41550	
Ang. 15°		HE-41650	
Ang. 25°		HE-41651	
Ball Attach			
Ø1.8 H 2mm		HE-41552	
Ø1.8 H 3mm		HE-41553	
Ø2.5 Swivel H 2mm		109BRK2R	
Ø2.5 Swivel H 3mm		109BRK3R	
Ø2.5 Swivel H 4mm		109BRK4R	
Retention Inserts			
Retention Inserts Ø1.8		192ACM	
Standard Retention Kit (1100 gr) Ø1.8 (6U)		040CRM	
Light Retention Kit (900 gr) Ø1.8 (6U)		040CRMSN	
Retention Inserts Ø2.5		192ACN	
Standard Retention Kit (1300 gr) Ø2.5 (6U)		040CRN	
Light Retention Kit (900 gr) Ø2.5 (6U)		040CRNSN	
Directional Rings		100AD	
Scanbody			
Intraoral Titanium	IBO 1101 702	IBO 1102 702	IBO 1103 702
Laboratory Peek	HE-35770	HE-41770	HE-51771
1G TiBase			
Engaging		HE-41751	
Non-Engaging		HE-41750	



	NP Ø3.5	RP Ø4.1	WP Ø5.1
AC 2G TiBase			
Engaging H 0.5mm	IBO 1101 620	IBO 1102 620	IBO 1103 620
Engaging H 1.5mm		IBO 1102 622	
Engaging H 2.5mm		IBO 1102 624	
Non-Engaging H 0.5mm	IBO 1101 621	IBO 1102 621	IBO 1103 621
Non-Engaging H 1.5mm		IBO 1102 623	
Non-Engaging H 2.5mm		IBO 1102 625	



3G TiBase			
Engaging H 0.5mm	HE-35741	HE-41741	
Engaging H 1.5mm	HE-35743	HE-41743	
Engaging H 2.5mm	HE-35745	HE-41745	
Non-Engaging H 0.5mm	HE-35740	HE-41740	
Non-Engaging H 1.5mm	HE-35742	HE-41742	
Non-Engaging H 2.5mm	HE-35744	HE-41744	



Multiunit Uniblock Abutment			
H 1mm	HE-35801	HE-48801	HE-51801
H 2mm	HE-35802	HE-48802	HE-51802
H 3mm	HE-35803	HE-48803	HE-51803
H 4mm		HE-48804	
H 5mm		HE-48805	
H 7mm with screw		HE-48807	
ZYGOMATIC + Screw H 1mm		HE-48861	
ZYGOMATIC + Screw H 2mm		HE-48862	
ESTHETICONE + Screw H 1mm		HE-48871	
ESTHETICONE + Screw H 2mm		HE-48872	
ESTHETICONE + Screw H 3mm		HE-48873	



Multiunit Angled Abutment			
17° H 2mm	HE-35852	HE-48852	
17° H 3mm	HE-35853	HE-48853	
17° H 4mm		HE-48854	
30° H 3mm	HE-35863	HE-48863	
30° H 4mm	HE-35864	HE-48864	
30° H 5mm		HE-48865	



Lock-Attach Abutment			
H 0.73mm	HE-35901	HE-41901	HE-51901
H 2mm	HE-35902	HE-41902	HE-51902
H 3mm	HE-35903	HE-41903	HE-51903
H 4mm	HE-35904	HE-41904	HE-51904
H 5mm	HE-35905	HE-41905	HE-51905
H 6mm		HE-41906	



Angled H 1.5mm		HE-41951	
Angled H 3mm		HE-41953	

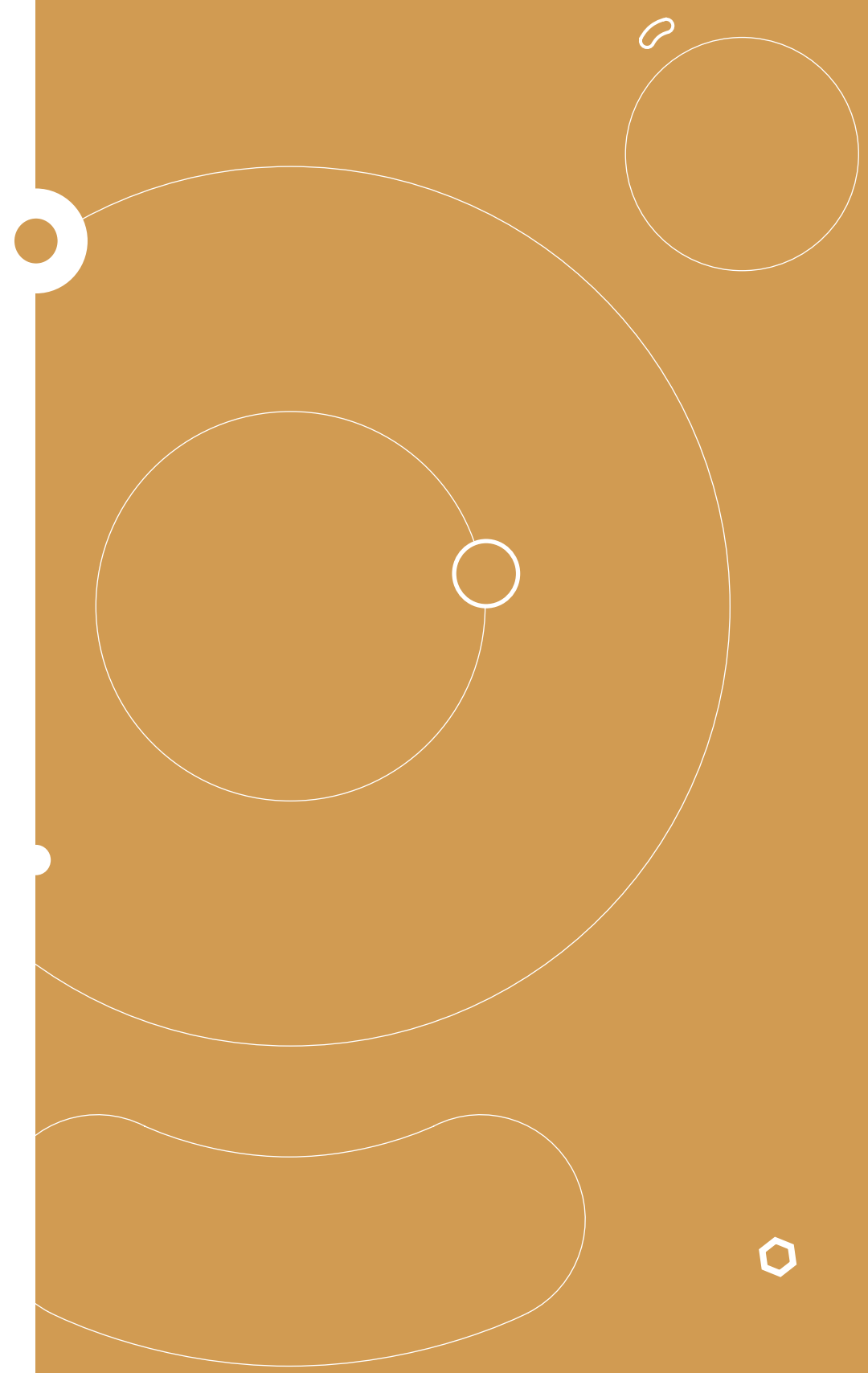









NOBEL BIOCARE® REPLACE®

Ø3.5 / Ø4.3 / Ø5.0



	NP Ø3.5	RP Ø4.3	WP Ø5.0
 Analogue			
	HEZ-35300	HEZ-43300	HEZ-50300
 Digital Analogue Screw			
M1.6 w/hex. 1.20	HE-41215	HE-41215	HE-41215
 Impression Coping			
Open Tray (OT)	HEZ-35700	HEZ-43700	HEZ-50700
 Healing Cap			
H 3mm H 5mm	HEZ-35403 HEZ-35405	HEZ-43403 HEZ-43405	HEZ-50403 HEZ-50405
 Screw			
M1.8 Unigrip M2 Unigrip	HEZ-35200	HEZ-43200	HEZ-43200
M1.8 Four-Lobed ACS M2 Four-Lobed ACS	IBO 1301 225	IBO 1302 225	IBO 1302 225
 Castable			
Engaging Non-Engaging	HEZ-35001 HEZ-35010	HEZ-43001 HEZ-43010	HEZ-50001 HEZ-50010
 CoCr Base Castable			
Engaging Non-Engaging	HEZ-35110 HEZ-35100	HEZ-43110 HEZ-43100	HEZ-50110 HEZ-50100
 CoCr Base Angled Chimney			
17° 30°	IBO 1102 011 IBO 1102 012	IBO 1102 013	IBO 1102 013

	NP Ø3.5	RP Ø4.3	WP Ø5.0
 Straight Abutment			
Engaging 1mm cementable	HEZ-35510	HEZ-43510	HEZ-50510
 Temporary Abutment			
Engaging Non-Engaging	HEZ-35600 HEZ-35610	HEZ-43600 HEZ-43610	HEZ-50600 HEZ-50610
 Scanbody			
Intraoral Titanium Laboratory Peek	IBO 1301 702 HEZ-35770	IBO 1302 702 HEZ-43770	IBO 1303 702 HEZ-50770
 AC 2G TiBase			
Engaging H 1mm Non-Engaging H 1mm	IBO 1301 620 IBO 1301 621	IBO 1302 620 IBO 1302 621	IBO 1303 620 IBO 1303 621
 Multiunit Uniblock			
H 1mm H 2mm H 3mm H 4mm H 5mm	HEZ-35801 HEZ-35802 HEZ-35803	HEZ-43801 HEZ-43802 HEZ-43803 HEZ-43804 HEZ-43805	HEZ-50801 HEZ-50802 HEZ-50803
 Multiunit Angled Abutment			
17° H 2mm 17° H 3mm 17° H 4mm 30° H 4mm 30° H 5mm		HEZ-43852 HEZ-43853 HEZ-43854 HEZ-43864 HEZ-43865	
 Lock-Attach Abutment			
H 0mm H 1mm H 2mm H 3mm H 4mm H 5mm H 6mm	HEZ-35900 HEZ-35901 HEZ-35902 HEZ-35903 HEZ-35904 HEZ-35905 HEZ-35906	HEZ-43900 HEZ-43901 HEZ-43902 HEZ-43903 HEZ-43904 HEZ-43905 HEZ-43906	HEZ-50901 HEZ-50902 HEZ-50903 HEZ-50904 HEZ-50905

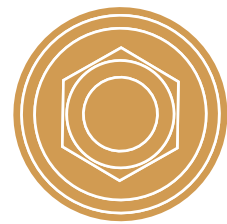

NOBEL BIOCARE® ACTIVE®

Ø3.0 / NP Ø3.5 / RP Ø4.3



	Ø3.0	NP Ø3.5	RP Ø4.3
Analogue			
Multiunit Mini Abutment	HEC-30300	HEC-35300 HEC-35301	HEC-43300
Digital Analogue Screw			
M1.6 w/hex. 1.20	HE-41215	HE-41215	HE-41215
Impression Coping			
Open Tray (OT)	HEC-30700	HEC-35700	HEC-43700
Impression Coping OT	HEC-30701		
Open tray Multiunit Mini Abutment		HEC-35720	
Healing Cap			
H 1.5mm		HEC-35401	
H 2.5mm		HEC-35402	
H 3mm	HEC-30403		HEC-43403
H 3.5mm		HEC-35403	
H 4.5mm		HEC-35404	
H 5mm	HEC-30405		HEC-43405
H 5.5mm		HEC-35405	
H 7mm		HEC-35407	HEC-43407
Multiunit Mini Abutment		HEC-35450	
Screw			
M1.4 w/hex. 1.20	HEC-30200		
M1.6 Unigrip		HE-35200	
M1.6 Unigrip DLC		HE-35280	
M2 Unigrip			HEC-43200
M2 Unigrip DLC			HEC-43280
M1.6 Gold w/Unigrip		HEC-35206	
M2 Gold w/Unigrip			HEC-43206
Cover Screw	HEC-30210	HEC-35210	HEC-43210
M1.6 Four-Lobed ACS		IBO 1401 225	
M2 Four-Lobed ACS			IBO 1402 225
Castable			
Engaging	HEC-30001	HEC-35001	HEC-43001
Non-Engaging		HEC-35010	HEC-43010
Multiunit Mini Abutment		HEC-35011	

	Ø3.0	NP Ø3.5	RP Ø4.3
CoCr Base Castable			
Engaging	HEC-30110	HEC-35110	HEC-43110
Non-Engaging		HEC-35100	HEC-43100
CoCr Base Angled Chimney			
17°		IBO 1102 011	IBO 1102 013
30°		IBO 1102 012	IBO 1102 014
Temporary Abutment			
Engaging	HEC-30600	HEC-35600	HEC-43600
Non-Engaging		HEC-35610	HEC-43610
Engaging Peek	HEC-30601		
Multiunit Mini Abutment		HEC-35620	
Straight / Angled Abutment			
Engaging H 7mm	HEC-30507		
Engaging H 9mm	HEC-30509		
15°	HEC-30650		
Scanbody			
Intraoral Titanium	IBO 0301 702	IBO 1401 702	IBO 1402 702
Laboratory Peek		HEC-35770	HEC-43770
Multiunit Mini Abutment		HEC-35771	
1G TiBase			
Engaging	HEC-30751	HEC-35751	HEC-43751
Non-Engaging		HEC-35750	HEC-43750
AC 2G TiBase			
Engaging H 1mm		IBO 1401 620	IBO 1402 620
Engaging H 2mm		IBO 1401 622	IBO 1402 622
Engaging H 3mm		IBO 1401 624	IBO 1402 624
Non-Engaging H 1mm		IBO 1401 621	IBO 1402 621
Non-Engaging H 2mm		IBO 1401 623	IBO 1402 623
Non-Engaging H 3mm		IBO 1401 625	IBO 1402 625
3G TiBase			
Engaging H 1mm	HEC-30741	HEC-35741	HEC-43741
Engaging H 2mm	HEC-30743	HEC-35743	HEC-43743
Engaging H 3mm	HEC-30745	HEC-35745	HEC-43745
Non-Engaging H 1mm	HEC-30740	HEC-35740	HEC-43740
Non-Engaging H 2mm	HEC-30742	HEC-35742	HEC-43742
Non-Engaging H 3mm	HEC-30744	HEC-35744	HEC-43744
Non-Engaging for Mini Abutment		HEC-35755	



Multiunit Uniblock

	Ø3.0	NP Ø3.5	RP Ø4.3
H 1.5mm		HEC-35801	HEC-43801
H 2.5mm		HEC-35802	HEC-43802
H 3.5mm		HEC-35803	HEC-43803
H 4.5mm		HEC-35804	HEC-43804
H 5.5mm		HEC-35805	
H 1.5mm Multiunit Mini Abutment		HEC-35811	
H 2.5mm Multiunit Mini Abutment		HEC-35812	
H 3.5mm Multiunit Mini Abutment		HEC-35813	
H 4.5mm Multiunit Mini Abutment		HEC-35814	
H 5.5mm Multiunit Mini Abutment		HEC-35815	



Multiunit Angled Abutment

17° H 2.5mm		HEC-35852	HEC-43852
17° H 3.5mm		HEC-35853	HEC-43853
30° H 3.5mm		HEC-35863	HEC-43863
30° H 4.5mm		HEC-35864	HEC-43864



Lock-Attach Abutment

H 1mm		HEC-35901	HEC-43901
H 2mm		HEC-35902	HEC-43902
H 3mm		HEC-35903	HEC-43903
H 4mm		HEC-35904	HEC-43904
H 5mm		HEC-35905	HEC-43905
H 6mm		HEC-35906	HEC-43906

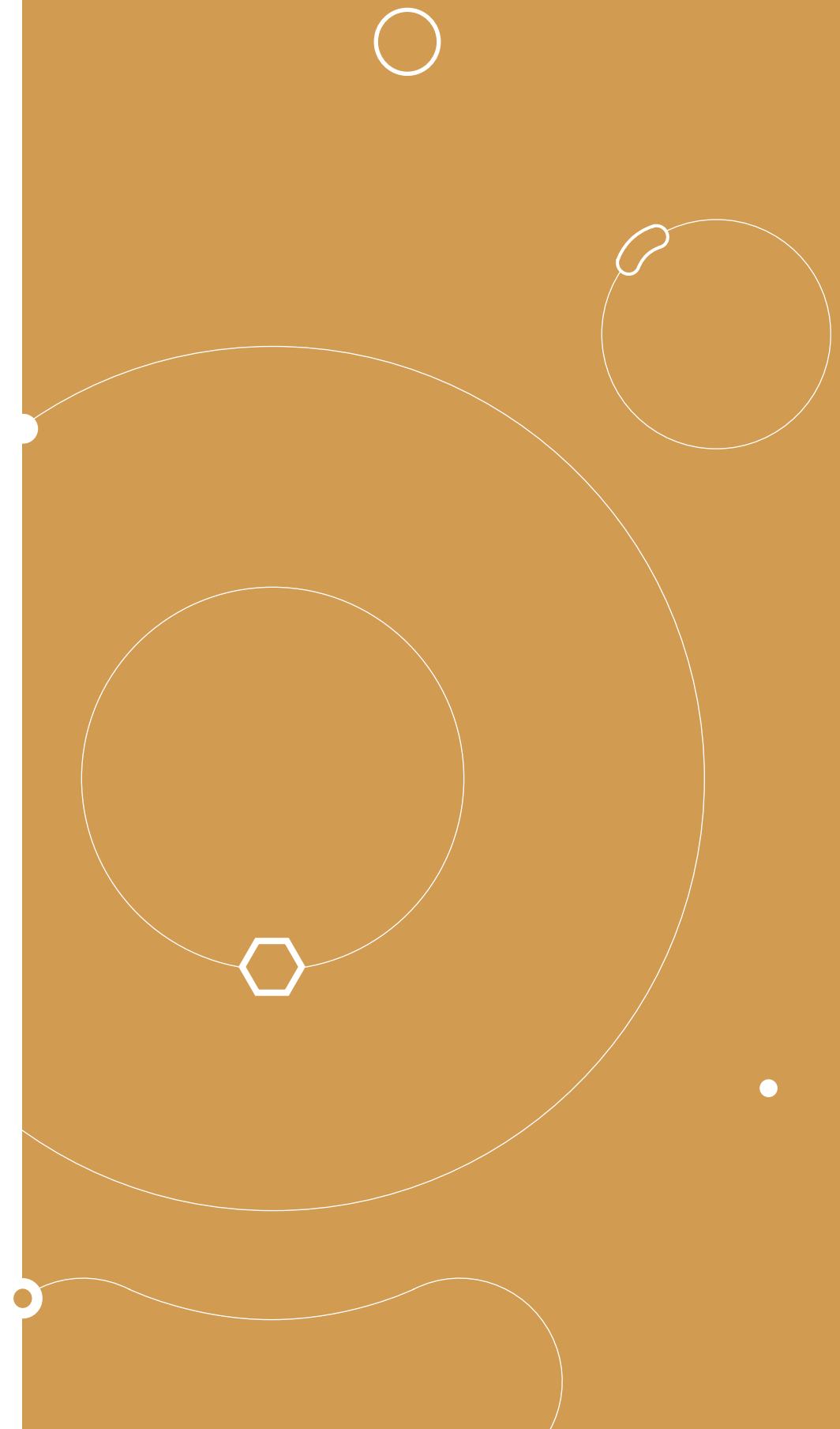



Ice cubes at x20 zoom

ZIMMER®

HEI CAD/CAM 1500
SCREW VENT®

Ibodontit S.L. has no connection with any of the brands listed above, which are the property of their respective trademark holders

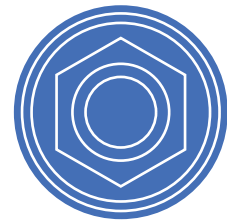

ZIMMER® SCREW VENT®

Ø3.5 / Ø4.5 / Ø5.7



	NP Ø3.5	RP Ø4.5	WP Ø5.7
Analogue			
	Ø3.5 plat 3.7 - HEI-35300 Ø3.5 plat 4.0 - HEI-35301		
		HEI-45300	HEI-57300
Digital Analogue Screw			
M1.6 w/hex. 1.20	HE-41215	HE-41215	HE-41215
Impression Coping			
Open Tray (OT)	HEI-35700	HEI-45700	HEI-57700
Closed Tray (CT)	HEI-35710		
Impression Coping OT	HEI-35701		
Impression Coping CT	HEI-35711		
Healing Cap			
H 2mm	HEI-35402		
H 3mm	HEI-35403	HEI-45403	HEI-57403
H 4mm	HEI-35404	HEI-45404	
H 5mm	HEI-35405	HEI-45405	HEI-57405
Screw			
M1.8 w/hex. 1.20	HEI-35200	HEI-35200	HEI-35200
M1.8 w/hex. 1.27	HEI-35201	HEI-35201	HEI-35201
M1.8 w/hex. 1.20 DLC	HEI-35280	HEI-35280	HEI-35280
M1.8 w/hex. 1.25 Self-locking	HEI-35205	HEI-35205	HEI-35205
M1.8 w/hex.1.20 Gold	HEI-35206	HEI-35206	HEI-35206
M1.8 Cover Screw	HEI-35210		
M1.8 Four-Lobed ACS	IBO 1501 225	IBO 1501 225	IBO 1501 225
Castable			
Engaging Ø3.5 plat 3.7	HEI-35001		
Non-Engaging Ø3.5 plat 3.7	HEI-35010		
Engaging Ø3.5 plat 4.0	HEI-35002		
Non-Engaging Ø3.5 plat 4.0	HEI-35011		
Engaging		HEI-45001	HEI-57001
Non-Engaging		HEI-45010	HEI-57010

	NP Ø3.5	RP Ø4.5	WP Ø5.7
CoCr Base Castable			
Engaging	HEI-35110	HEI-45110	HEI-57110
Non-Engaging	HEI-35100	HEI-45100	
CoCr Base Angled Chimney			
17°	IBO 1102 011	IBO 1102 011	
30°	IBO 1102 012	IBO 1102 012	
Temporary Abutment			
Engaging	HEI-35600	HEI-45600	
Non-Engaging	HEI-35610	HEI-45610	
Straight / Angled Abutment			
Straight Engaging	HEI-35505		
Ang. 15°	HEI-35650		
Ang. 25°	HEI-35651		
Ball Attach			
Ø1.8 H 2mm	HEI-35552		
Ø1.8 H 4mm	HEI-35554		
Ø2.5 Swivel H 2mm	109CV2R		
Ø2.5 Swivel H 4mm	109CV4R		
 <ul style="list-style-type: none"> Retention Inserts Ø1.8 Standard Retention Kit (1100 gr) Ø1.8 (6ud) Light Retention Kit (900 gr) Ø1.8 (6ud) Retention Inserts Ø 2.5 Standard Retention Kit (1300 gr) Ø2.5 (6ud) Light Retention Kit (900 gr) Ø2.5 (6ud) Directional Rings 			
Scanbody			
Intraoral Titanium	IBO 1501 702	IBO 1502 702	IBO 1503 702
Laboratory Peek	HEI-35770	HEI-45770	HEI-57770
1G TiBase			
Engaging	HEI-35751	HEI-45751	
Non-Engaging	HEI-35750	HEI-45750	
AC 2G TiBase			
Engaging H 0.5mm	IBO 1501 620	IBO 1502 620	IBO 1503 620
Engaging H 1.5mm	IBO 1501 622	IBO 1502 622	
Engaging H 2.5mm	IBO 1501 624		
Non-Engaging H 0.5mm	IBO 1501 621	IBO 1502 621	IBO 1503 621
Non-Engaging H 1.5mm	IBO 1501 623	IBO 1502 623	
Non-Engaging H 2.5mm	IBO 1501 625		



3G TiBase

	NP Ø3.5	RP Ø4.5	WP Ø5.7
Engaging H 0.5mm	HEI-35741	HEI-45741	
Engaging H 1.5mm	HEI-35743	HEI-45743	
Engaging H 2.5mm	HEI-35745		
Non-Engaging H 0.5mm	HEI-35740	HEI-45740	
Non-Engaging H 1.5mm	HEI-35742	HEI-45742	
Non-Engaging H 2.5mm	HEI-35744		



Multiunit Uniblock Abutment

H 1mm	HEI-35801	HEI-45801
H 2mm	HEI-35802	HEI-45802
H 3mm	HEI-35803	HEI-45803
H 4mm	HEI-35804	HEI-45804
H 5mm	HEI-35805	HEI-45805



Multiunit Angled Abutment

17° H 2mm	HEI-35852	HEI-45852
17° H 3mm	HEI-35853	HEI-45853
17° H 4mm	HEI-35854	HEI-45854
30° H 4mm	HEI-35864	HEI-45864
30° H 5mm	HEI-35865	HEI-45865
30° H 6mm	HEI-35866	HEI-45866



Lock-Attach Abutment

H 1mm	HEI-35901	HEI-45901	HEI-57901
H 2mm	HEI-35902	HEI-45902	HEI-57902
H 3mm	HEI-35903	HEI-45903	HEI-57903
H 4mm	HEI-35904	HEI-45904	HEI-57904
H 5mm	HEI-35905	HEI-45905	HEI-57905
H 6mm	HEI-35906	HEI-45906	



Angled H 1.5mm	HEI-35951
Angled H 3mm	HEI-35953

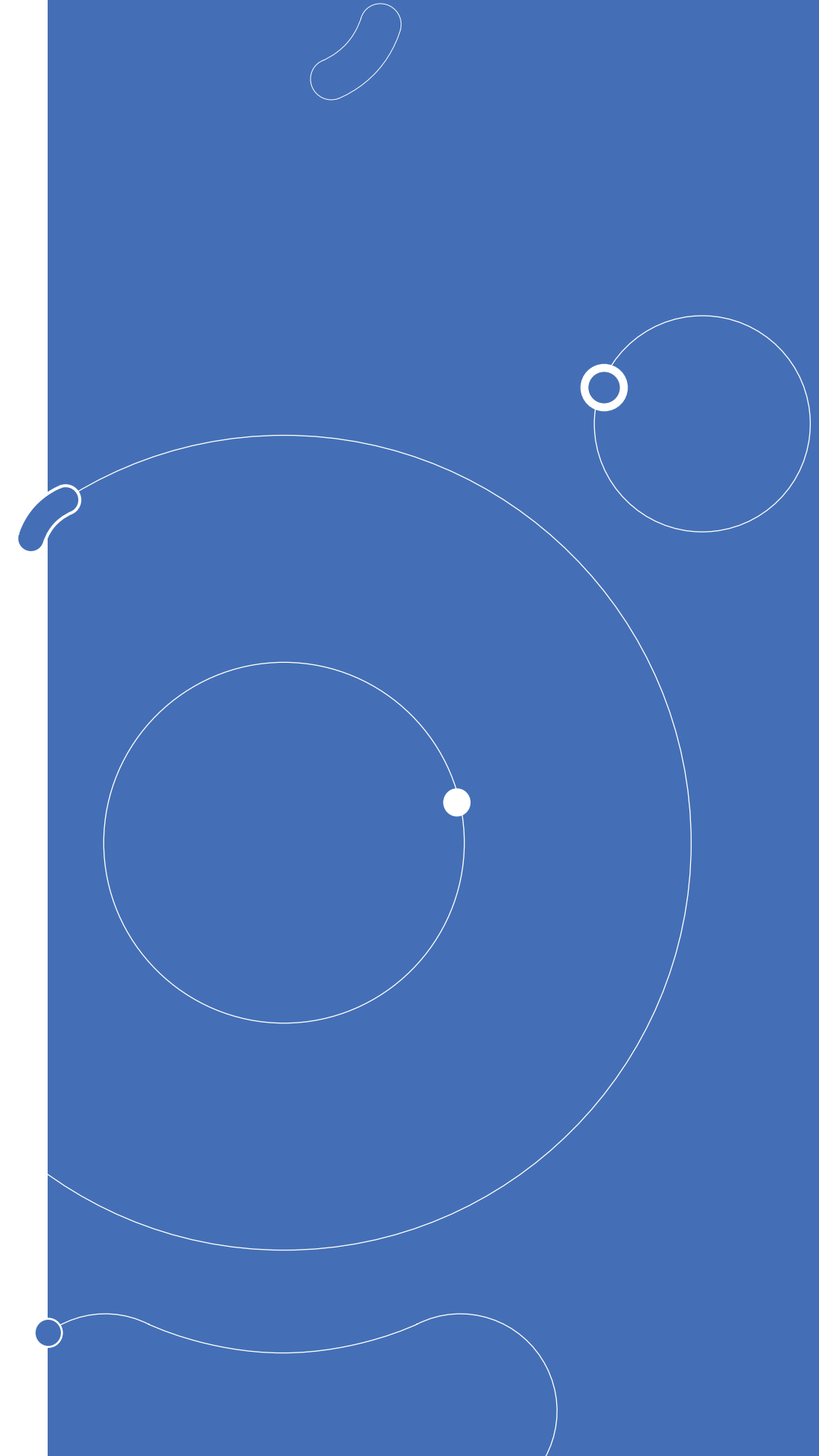

STRAUMANN®

HI CAD/CAM 1800
TISSUE LEVEL®

HI CAD/CAM 1900
BONE LEVEL®

CAD/CAM 3800
BLX®

Ibodontit S.L. has no connection with any of the brands listed above, which are the property of their respective trademark holders



Lettuce cells under microscope at x400 zoom

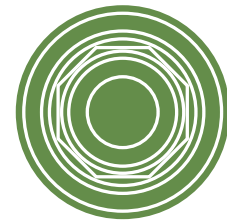

STRAUMANN® TISSUE LEVEL®

RN Ø4.8 / WN Ø6.5



	RN Ø4.8	WN Ø6.5
Analogue		
Implant Level Synocta	HI-48300 HI-48301	HI-65300
Digital Analogue Screw		
M1.6 w/hex. 1.20	HE-41215	HE-41215
Impression Coping		
Open Tray (OT) Synocta Cementable Abutment Open Tray	HI-48700 HI-48704	HI-65700
Healing Cap		
H 2mm H 3mm H 4.5mm	HI-48402 HI-48403 HI-48404	
Screw		
M2 Torx for Castable Implant Level	HI-48200	
M2 Torx	HI-48204	HI-48204
M2 Torx DLC	HI-48280	HI-48280
M2 Torx Self-locking	HI-48205	
M2 Gold Torx	HI-48206	HI-48206
M2 Torx for Synocta	HI-48201	
M2 Cover Screw	HI-48210	
M2 Special Cover Screw (H 1.5mm)	HI-48211	
M2 Four-Lobed ACS M2 Four-Lobed ACS for Synocta	IBO 1801 225 IBO 1801 226	IBO 1801 225 IBO 1801 226
Castable		
Engaging Implant Level	HI-48001	HI-65001
Non-Engaging Implant Level	HI-48010	HI-65010
Engaging for Synocta	HI-48002	
Non-Engaging for Synocta	HI-48011	
Engaging for Synocta Cementable	HI-48003	
Non-Engaging for Synocta Cementable	HI-48012	

	RN Ø4.8	WN Ø6.5
CoCr Base Castable		
Engaging Implant Level	HI-48110	HI-65110
Non-Engaging Implant Level	HI-48100	HI-65100
Engaging for Synocta	HI-48111	
Non-Engaging for Synocta	HI-48101	

CoCr Base Angled Chimney		
17° Implant Level	IBO 1102 013	
30° Implant Level	IBO 1102 014	
17° for Synocta	IBO 1102 011	
30° for Synocta	IBO 1102 012	

Temporary Abutment		
Engaging Implant Level	HI-48600	HI-65600
Non-Engaging Implant Level	HI-48611	HI-65610
Engaging for Synocta	HI-48615	
Non-Engaging for Synocta	HI-48610	

Synocta Straight Abutment		
Engaging H 4mm Cementable	HI-48504	
Engaging H 5mm Cementable	HI-48505	
Engaging H 7mm Cementable	HI-48507	
Synocta Abutment	HI-48530	
Octa Abutment	HI-48535	
Synocta Abutment Cementable	HI-48531	

Ball Attach		
Ø2.5 Swivel H 2mm	109BFT2R	
Ø2.5 Swivel H 4mm	109BFT4R	

Retention Inserts Ø 2.5	192ACN	
Standard Retention Kit (1300 gr) Ø2.5 (6ud)	040CRN	
Light Retention Kit (900 gr) Ø2.5 (6ud)	040CRNSN	
Directional Rings	100AD	

Scanbody		
Intraoral Titanium Implant Level	IBO 1801 703	IBO 1802 702
Laboratory Peek Implant Level	HI-48770	HI-65770
Intraoral Titanium for Synocta	IBO 1801 704	
Laboratory Peek for Synocta	HI-48771	

1G TiBase		
Engaging Implant Level	HI-48751	
Non-Engaging Implant Level	HI-48750	



AC 2G TiBase

	RN Ø4.8	WN Ø6.5
Engaging Implant Level	IBO 1801 620	IBO 1802 620
Non-Engaging Implant Level	IBO 1801 621	IBO 1802 621
Engaging for Synocta	IBO 1801 622	
Non-Engaging for Synocta	IBO 1801 623	



3G TiBase

Engaging H 0.9 Implant Level	HI-48741
Engaging H 2 Implant Level	HI-48743
Non-Engaging H 0.9 Implant Level	HI-48740
Non-Engaging H 2 Implant Level	HI-48742



Multiunit Uniblock Abutment

H 0.9mm	HI-48801
---------	----------



Multiunit Angled Abutment

17° H 2.5mm	HI-48852
30° H 3.5mm	HI-48863



Lock-Attach Abutment

H 1mm	HI-48901
H 2mm	HI-48902
H 3mm	HI-48903
H 4mm	HI-48904
H 5mm	HI-48905
H 6mm	HI-48906
 Angled H 1.5mm	HI-48951
Angled H 3mm	HI-48953

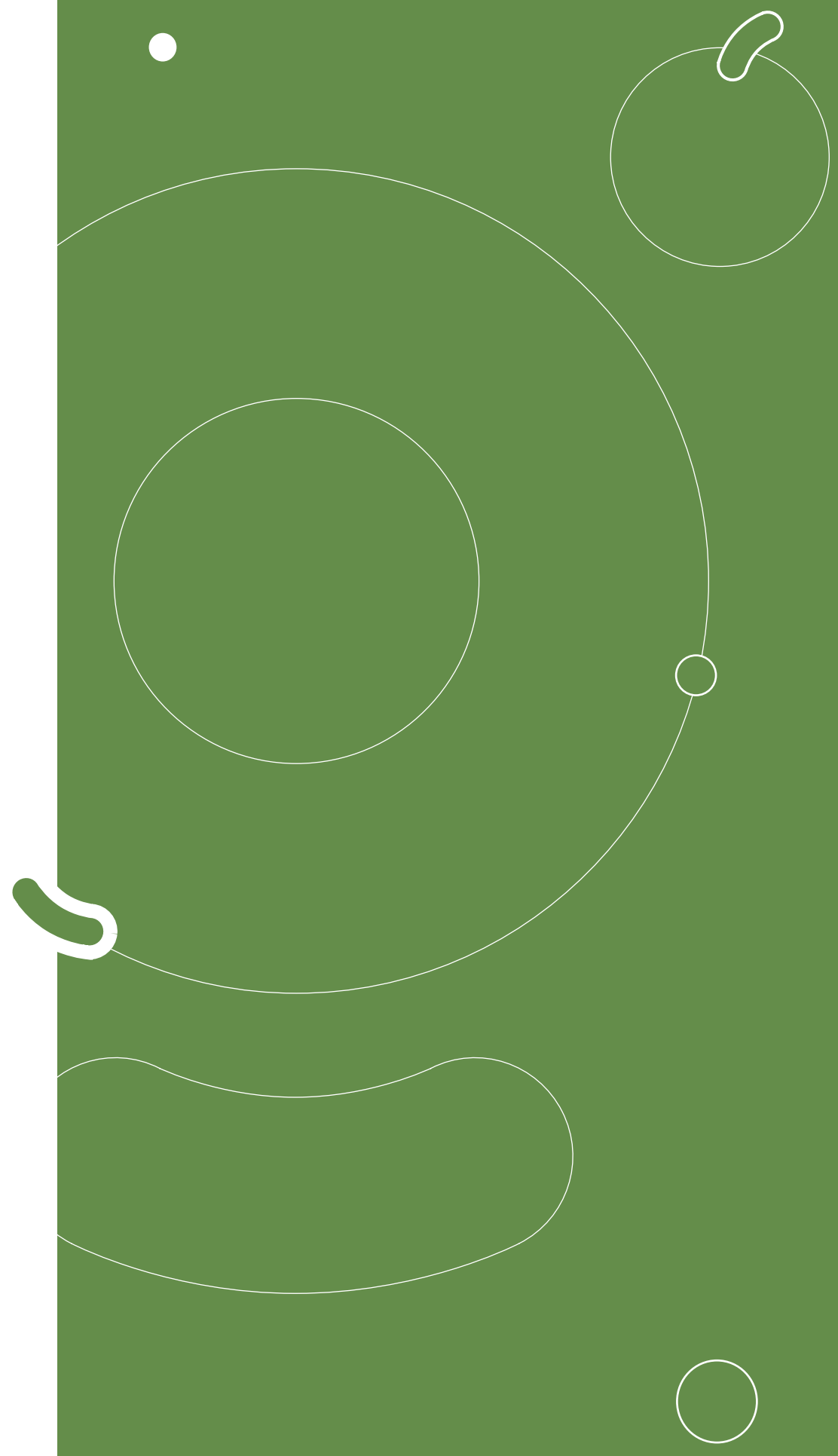

STRAUMANN®

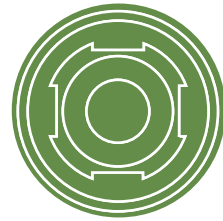

STRAUMANN® BONE LEVEL®

NC Ø3.3 / RC Ø4.1



	NC Ø3.3	RC Ø4.1
 Analogue		
	HI-33300	HI-41300
 Digital Analogue Screw		
M1.6 w/hex. 1.20	HE-41215	HE-41215
 Impression Coping		
Open Tray (OT)	HI-33700	HI-41700
 Healing Cap		
H 2mm	HI-33402	HI-41402
H 4mm	HI-33404	HI-41404
H 5mm	HI-33405	
H 6mm		HI-41406
 Screw		
M1.6 Torx	HI-33200	HI-41200
M1.6 Torx Gold	HI-33206	HI-41206
M1.6 Torx DLC	HI-33280	HI-41280
M1.6 Four-Lobed ACS	IBO 1902 225	IBO 1902 225
 Castable		
Engaging	HI-33001	HI-41001
Non-Engaging	HI-33010	HI-41010
 CoCr Base Castable		
Engaging	HI-33110	HI-41110
Non-Engaging	HI-33100	HI-41100
 CoCr Base Angled Chimney		
17°	IBO 1102 011	IBO 1102 011
25°	IBO 1102 015	IBO 1102 015



Temporary Abutment

	NC Ø3.3	RC Ø4.1
Engaging	HI-33600	HI-41600
Non-Engaging	HI-33610	HI-41610



Straight Abutment

	NC Ø3.3	RC Ø4.1
Engaging		HI-41501
Non-Engaging		HI-41550



Scanbody

	NC Ø3.3	RC Ø4.1
Intraoral Titanium	IBO 1901 702	IBO 1902 702
Laboratory Peek	HI-33770	HI-41770



AC 2G TiBase

	NC Ø3.3	RC Ø4.1
Engaging H 1mm	IBO 1901 620	IBO 1902 620
Engaging H 2mm	IBO 1901 622	IBO 1902 622
Engaging H 3mm	IBO 1901 624	IBO 1902 624
Non-Engaging H 1mm	IBO 1901 621	IBO 1902 621
Non-Engaging H 2mm	IBO 1901 623	IBO 1902 623
Non-Engaging H 3mm	IBO 1901 625	IBO 1902 625



3G TiBase

	NC Ø3.3	RC Ø4.1
Engaging H 1mm	HI-33741	HI-41741
Engaging H 2mm	HI-33743	HI-41743
Engaging H 3mm	HI-33745	HI-41745
Non-Engaging H 1mm	HI-33740	HI-41740
Non-Engaging H 2mm	HI-33742	HI-41742
Non-Engaging H 3mm	HI-33744	HI-41744



Multiunit Uniblock Abutment

	NC Ø3.3	RC Ø4.1
H 1.5mm	HI-33801	HI-41801
H 2.5mm	HI-33802	HI-41802
H 3.5mm	HI-33803	HI-41803
H 4.5mm	HI-33804	HI-41804



Multiunit Angled Abutment

	NC Ø3.3	RC Ø4.1
17° H 2.5mm	HI-33852	HI-41852
17° H 3.5mm	HI-33853	HI-41853
30° H 3.5mm	HI-33863	HI-41863
30° H 4.5mm	HI-33864	HI-41864



Lock-Attach Abutment

	NC Ø3.3	RC Ø4.1
H 1mm	HI-33901	HI-41901
H 2mm	HI-33902	HI-41902
H 3mm	HI-33903	HI-41903
H 4mm	HI-33904	HI-41904
H 5mm	HI-33905	HI-41905
H 6mm	HI-33906	HI-41906



STRAUMANN® BLX®

RB / WB



	RB / WB
 Analogue	
	IBO 3801 300
 Digital Analogue Screw	
M1.6 w/hex. 1.20	HE-41215
 Impression Coping	
Open Tray (OT)	IBO 3801 350
 Healing Cap	
H 2mm	IBO 3801 402
H 4mm	IBO 3801 404
H 6mm	IBO 3801 406
 Screw	
M1.6 Torx	IBO 3801 200
M1.6 Four-lobed ACS	IBO 3801 225
 CoCr Base Castable	
Engaging	IBO 3801 110
Non-Engaging	IBO 3801 100
 Temporary Abutment	
Engaging	IBO 3801 550
Non-Engaging	IBO 3801 555
 Scanbody	
Intraoral Titanium	IBO 3801 702



AC 2G TiBase

Engaging H 0.5
Non-Engaging H 0.5

RB / WB

IBO 3801 620
IBO 3801 621



3G TiBase

Engaging H 0.5
Engaging H 1.5
Engaging H 2.5
Non-Engaging H 0.5
Non-Engaging H 1.5
Non-Engaging H 2.5

IBO 3801 601
IBO 3801 603
IBO 3801 605
IBO 3801 600
IBO 3801 602
IBO 3801 604



Multiunit Uniblock Abutment

H 1.5mm
H 2.5mm
H 3.5mm
H 4.5mm

IBO 3801 801
IBO 3801 802
IBO 3801 803
IBO 3801 804



Multiunit Angled Abutment

17° H 2.5mm
17° H 3.5mm
30° H 3.5mm
30° H 4.5mm

IBO 3801 852
IBO 3801 853
IBO 3801 863
IBO 3801 864



Lock-Attach Abutment

H 1mm
H 2mm
H 3mm
H 4mm
H 5mm

IBO 3801 901
IBO 3801 902
IBO 3801 903
IBO 3801 904
IBO 3801 905

ASTRA TECH®

HEA CAD/CAM 2000
OSSEOSPEED Tx®

CAD/CAM 3200
EV®

Ibodontit S.L. has no connection with any of the brands listed above, which are the property of their respective trademark holders



Embers at x15 zoom



ASTRA TECH® OSSEOSPEED TX®

Ø3.0 / AQUA Ø3.5 - Ø4.0 / LILAC Ø4.5 - Ø5.0



CoCr Base Castable

	Ø3.0	AQUA Ø3.5 - 4.0	LILAC Ø4.5 - 5.0
Engaging	IBO 2003 110	HEA-35110	HEA-45110
Non-Engaging		HEA-35100	HEA-45100



CoCr Base Angled Chimney

	Ø3.0	AQUA Ø3.5 - 4.0	LILAC Ø4.5 - 5.0
17°		IBO 1102 011	
30°		IBO 1102 012	



Temporary Abutment

	Ø3.0	AQUA Ø3.5 - 4.0	LILAC Ø4.5 - 5.0
Engaging		HEA-35600	HEA-45600
Non-Engaging		HEA-35610	HEA-45610



Straight Abutment

	Ø3.0	AQUA Ø3.5 - 4.0	LILAC Ø4.5 - 5.0
Engaging		HEA-35500	HEA-45500
Non-Engaging		HEA-35550	HEA-45550



20° Angled Abutment

	Ø3.0	AQUA Ø3.5 - 4.0	LILAC Ø4.5 - 5.0
H 0.5mm		HEA-35551	HEA-45551
H 1mm		HEA-35552	HEA-45552
H 2mm		HEA-35553	HEA-45553
H 4mm		HEA-35554	HEA-45554



Scanbody

	Ø3.0	AQUA Ø3.5 - 4.0	LILAC Ø4.5 - 5.0
Intraoral Titanium	IBO 2003 702	IBO 2001 702	IBO 2002 702
Laboratory Peek		HEA-35770	HEA-45770



1G TiBase

	Ø3.0	AQUA Ø3.5 - 4.0	LILAC Ø4.5 - 5.0
Engaging		HEA-35751	
Non-Engaging		HEA-35750	



AC 2G TiBase

	Ø3.0	AQUA Ø3.5 - 4.0	LILAC Ø4.5 - 5.0
Engaging H 1mm	IBO 2003 620	IBO 2001 620	IBO 2002 620
Engaging H 2mm		IBO 2001 622	
Engaging H 3mm		IBO 2001 624	
Non-Engaging H 1mm		IBO 2001 621	IBO 2002 621
Non-Engaging H 2mm		IBO 2001 623	
Non-Engaging H 3mm		IBO 2001 625	



3G TiBase

	Ø3.0	AQUA Ø3.5 - 4.0	LILAC Ø4.5 - 5.0
20°		HEA-35780	
Engaging H 1mm		HEA-35741	HEA-45741
Engaging H 2mm		HEA-35743	HEA-45743
Engaging H 3mm		HEA-35745	
Non-Engaging H 1mm		HEA-35740	HEA-45740
Non-Engaging H 2mm		HEA-35742	HEA-45742
Non-Engaging H 3mm		HEA-35744	

	Ø3.0	AQUA Ø3.5 - 4.0	LILAC Ø4.5 - 5.0
Analogue			
	IBO 2003 300	HEA-35300	HEC-43300
Digital Analogue Screw			
M1.6 w/hex. 1.20	HE-41215	HE-41215	HE-41215
20° Analogue		HEA-35301	
Impression Coping			
Open Tray (OT)	IBO 2003 350	HEA-35700	HEA-45700
Closed Tray (CT)		HEA-35710	
Healing Cap			
H 2mm	IBO 2003 402	HEA-35402	HEA-45402
H 4mm	IBO 2003 404	HEA-35404	HEA-45404
H 5mm		HEA-35406	HEA-45406
Screw			
M1.4 w/hex. 1.27	IBO 2003 200		
M1.6 w/hex. 1.27		HEA-35200	
20° M1.6 w/hex. 1.27		HEA-35201	
M1.6 w/hex. 1.27 DLC		HEA-35280	
M2 w/hex. 1.27			HEA-45200
M1.6 Four-Lobed ACS		IBO 2001 225	
M2 Four-Lobed ACS			IBO 1302 225
Castable			
Engaging		HEA-35001	HEA-45001
Non-Engaging		HEA-35010	HEA-45010
20°		HEA-35011	



Multiunit Uniblock Abutment

Ø3.0	AQUA Ø3.5 - 4.0	LILAC Ø4.5 - 5.0
H 0.5mm	HEA-35800	
H 1.5mm	HEA-35801	HEA-45801
H 2.5mm	HEA-35802	HEA-45802
H 3.5mm	HEA-35803	HEA-45803
H 4.5mm	HEA-35804	HEA-45804



Multiunit Angled Abutment

17° H 2.5mm	HEA-35852	HEA-45852
17° H 3.5mm	HEA-35853	HEA-45853
30° H 3.5mm	HEA-35863	HEA-45863
30° H 4.5mm	HEA-35864	HEA-45864



Lock-Attach Abutment



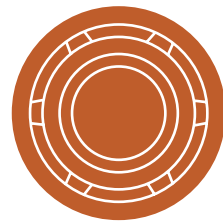



H 0.5mm		HEA-45901
H 1mm	HEA-35901	
H 2mm	HEA-35902	HEA-45902
H 3mm	HEA-35903	HEA-45903
H 4mm	HEA-35904	HEA-45904
H 5mm	HEA-35905	HEA-45905



ASTRA TECH® EV®

Ø3.0 / Ø3.6 / Ø4.2 / Ø4.8



	Ø3.0	Ø3.6	Ø4.2	Ø4.8
 Analogue				
	IBO 3201 300	IBO 3202 300	IBO 3203 300	IBO 3204 300
 Digital Analogue Screw				
M1.6 w/hex. 1.20	HE-41215	HE-41215	HE-41215	HE-41215
 33° Analogue				
		IBO 3203 301	IBO 3203 301	IBO 3203 301
 Impression Coping				
Open Tray (OT)		IBO 3202 350	IBO 3203 350	IBO 3204 350
 Healing Cap				
H 2mm	IBO 3201 402	IBO 3202 402	IBO 3203 402	IBO 3204 402
H 4mm	IBO 3201 404	IBO 3202 404	IBO 3203 404	IBO 3204 404
 Screw				
M1.4 w/hex. 1.27	IBO 3201 200			
M1.6 w/hex. 1.27		IBO 3202 200		
M1.8 w/hex. 1.27			IBO 3203 200	
M2 w/hex. 1.27				IBO 3204 200
M1.6 Four-Lobed ACS		IBO 3202 225		
M1.8 Four-Lobed ACS			IBO 3203 225	
M2 Four-Lobed ACS				IBO 3204 225
 Castable				
Engaging	IBO 3201 001	IBO 3202 001	IBO 3203 001	IBO 3204 001
Non-Engaging		IBO 3202 010	IBO 3203 010	IBO 3204 010

	Ø3.0	Ø3.6	Ø4.2	Ø4.8
 CoCr Base Castable				
Engaging	IBO 3201 110	IBO 3202 110	IBO 3203 110	IBO 3204 110
Non-Engaging		IBO 3202 100	IBO 3203 100	IBO 3204 100
 CoCr Base Angled Chimney				
17°		IBO 1102 011	IBO 1102 011	IBO 1102 013
30°		IBO 1102 012	IBO 1102 012	IBO 1102 014
 Temporary Abutment				
Engaging		IBO 3202 550	IBO 3203 550	IBO 3204 550
Non-Engaging		IBO 3202 555	IBO 3203 555	IBO 3204 555
 Scanbody				
Intraoral Titanium	IBO 3201 702	IBO 3202 702	IBO 3203 702	IBO 3204 702
Laboratory Peek	IBO 3201 700	IBO 3202 700	IBO 3203 700	IBO 3204 700
 AC 2G TiBase				
Engaging H 1mm	IBO 3201 620	IBO 3202 620	IBO 3203 620	IBO 3204 620
Non-Engaging H 1mm		IBO 3202 621	IBO 3203 621	IBO 3204 621
 3G TiBase				
Engaging H 1mm		IBO 3202 601	IBO 3203 601	
Engaging H 2mm		IBO 3202 603	IBO 3203 603	
Non-Engaging H 1mm		IBO 3202 600	IBO 3203 600	
Non-Engaging H 2mm		IBO 3202 602	IBO 3203 602	
 Multiunit Uniblock Abutment				
H 1.5mm		IBO 3202 801	IBO 3203 801	IBO 3204 801
H 2.5mm		IBO 3202 802	IBO 3203 802	IBO 3204 802
H 3.5mm		IBO 3202 803	IBO 3203 803	IBO 3204 803
H 4.5mm		IBO 3202 804	IBO 3203 804	IBO 3204 804
 Multiunit Angled Abutment				
17° H 2.5mm		IBO 3202 852	IBO 3203 852	IBO 3204 852
17° H 3.5mm		IBO 3202 853	IBO 3203 853	IBO 3204 853
30° H 3.5mm		IBO 3202 864	IBO 3203 864	IBO 3204 864
30° H 4.5mm		IBO 3202 865	IBO 3203 865	IBO 3204 865
 Lock-Attach Abutment				
H 1mm		IBO 3202 901	IBO 3203 901	IBO 3204 901
H 2mm		IBO 3202 902	IBO 3203 902	IBO 3204 902
H 3mm		IBO 3202 903	IBO 3203 903	IBO 3204 903
H 4mm		IBO 3202 904	IBO 3203 904	IBO 3204 904

BIOMET 3i[®]

HE
HEW

CAD/CAM 2100
EXTERNAL HEX.[®]

CAD/CAM 2200
CERTAIN[®]

Ibodontit S.L. has no connection with any of the brands listed above, which are the property of their respective trademark holders









Honeycomb at x40 zoom



BIOMET 3i[®] EXTERNAL HEX.®

Ø3.25 / Ø4.1 / Ø5.0



	NP Ø3.25	RP Ø4.1	WP Ø5.0
 Analogue			
	IBO 2101 300	HE-41300	HE-51300
 Digital Analogue Screw			
M1.6 w/hex. 1.20	HE-41215	HE-41215	HE-41215
 Impression Coping			
Open Tray (OT)		HE-41700	HE-51700
Impression Coping OT		HE-41701	
Closed Tray (CT)		HE-41710	
Impression Coping CT		HE-41711	
 Healing Cap			
H 2mm		HE-41402	
H 3mm		HE-41403	HE-51403
H 4mm		HE-41404	
H 5mm		HE-41405	HE-51405
 Screw			
M2 w/hex. 1.20	IBO 2101 200	HE-41200	HE-41200
M2 w/hex. 1.20 DLC		HE-41280	HE-41280
M2 Flat Seat w/hex. 1.20		HE-41201	HE-41201
M2 Square 1.30		HE-41202	HE-41202
M2 w/hex. 1.25		HE-41203	HE-41203
M2 Flat w/hex. 1.20		HE-41204	HE-41204
M2 Self-locking M2 w/hex. 1.25		HE-41205	HE-41205
M2 Screw Gold M2 w/hex.1.20		HE-41206	HE-41206
M2 Unigrip		HE-41207	HE-41207
M2 w/hex. 1.20 Fully Threaded		HE-41208	HE-41208
M2 Cover Screw		HE-41210	
M2 Four-Lobed ACS		IBO 1102 225	
 Castable			
Engaging	IBO 2101 001	HE-41001	HE-51001
Non-Engaging	IBO 2101 010	HE-41010	HE-51010

	NP Ø3.25	RP Ø4.1	WP Ø5.0
 CoCr Base Castable			
Engaging	IBO 2101 110	HE-41110	HE-51111
Non-Engaging	IBO 2101 100	HE-41100	HE-51101
 CoCr Base Angled Chimney			
17°		IBO 1102 011	
30°		IBO 1102 012	
 Temporary Abutment			
Engaging		HE-41600	HE-51600
Non-Engaging		HE-41610	HE-51610
 Straight Abutment			
Engaging		HE-41500	
Non-Engaging		HE-41550	
 Angled Abutment			
15°		HE-41650	
25°		HE-41651	
 Scanbody			
Intraoral Titanium	IBO 2101 702	IBO 1102 702	IBO 2103 702
Laboratory Peek	IBO 2101 700	HE-41770	HE-51770
 1G TiBase			
Engaging		HE-41751	
Non-Engaging		HE-41750	
 AC 2G TiBase			
Engaging H 0.5mm	IBO 2101 620	IBO 1102 620	IBO 2103 620
Engaging H 1.5mm		IBO 1102 622	
Engaging H 2.5mm		IBO 1102 624	
Non-Engaging H 0.5mm	IBO 2101 621	IBO 1102 621	IBO 2103 621
Non-Engaging H 1.5mm		IBO 1102 623	
Non-Engaging H 2.5mm		IBO 1102 625	
 3G TiBase			
Engaging H 0.5mm		HE-41741	
Engaging H 1.5mm		HE-41743	
Engaging H 2.5mm		HE-41745	
Non-Engaging H 0.5mm		HE-41740	
Non-Engaging H 1.5mm		HE-41742	
Non-Engaging H 2.5mm		HE-41744	

NP Ø3.25 RP Ø4.1 WP Ø5.0



Multiunit Uniblock Abutment

H 1mm	HE-48801
H 2mm	HE-48802
H 3mm	HE-48803
H 4mm	HE-48804
H 5mm	HE-48805
H 7mm w/ screw	HE-48807



Multiunit Angled Abutment

17° H 2mm	HE-48852
17° H 3mm	HE-48853
17° H 4mm	HE-48854
30° H 3mm	HE-48863
30° H 4mm	HE-48864
30° H 5mm	HE-48865



Lock-Attach Abutment

H 0.73mm	HE-41901
H 2mm	HE-41902
H 3mm	HE-41903
H 4mm	HE-41904
H 5mm	HE-41905
H 6mm	HE-41906
Angled H 1.5mm	HE-41951
Angled H 3mm	HE-41953

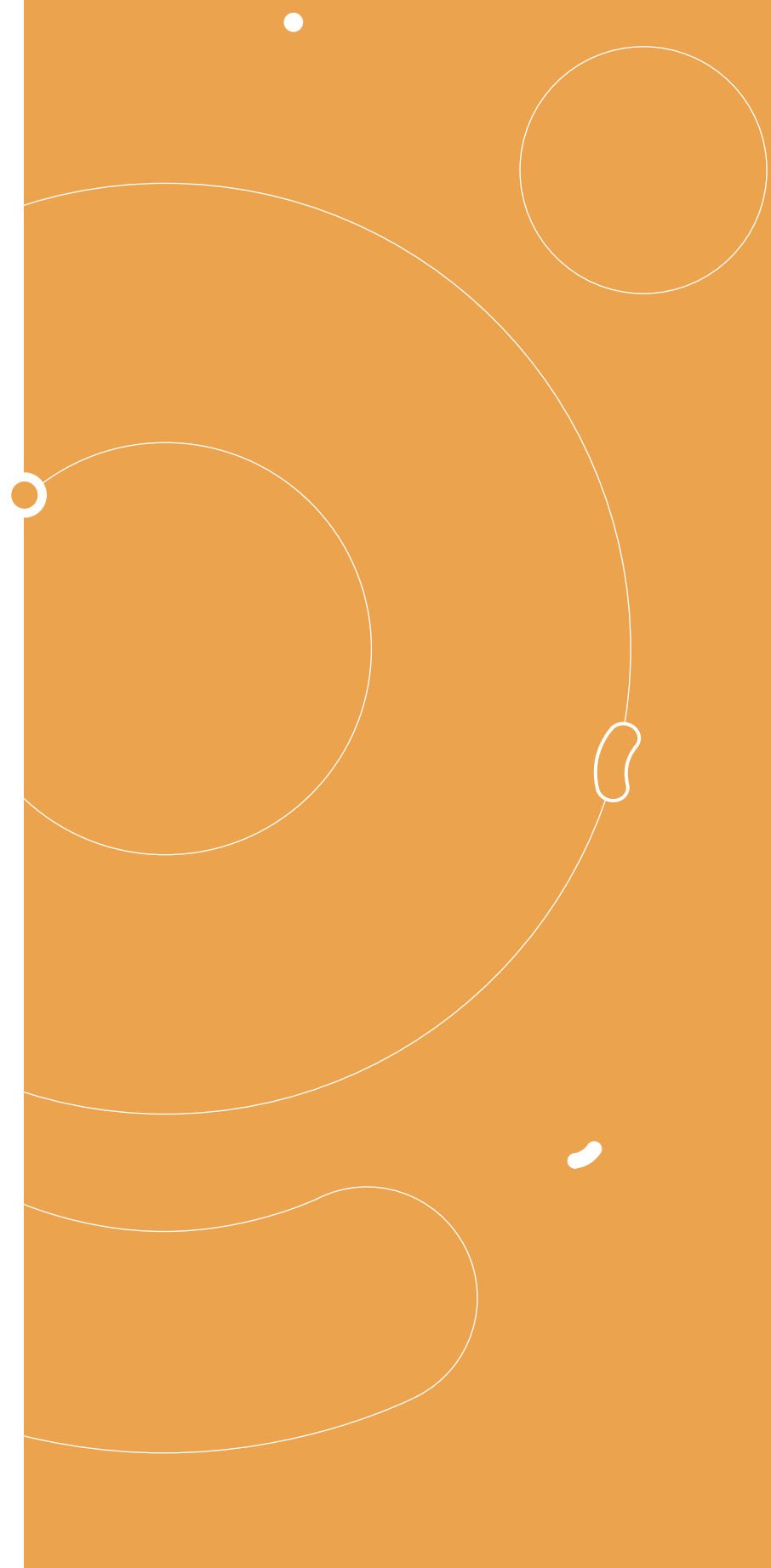



BIOMET 3i[®] CERTAIN[®]

Ø3.4 / Ø4.1 / Ø5.0



	NP Ø3.4	RP Ø4.1	WP Ø5.0
 Analogue			
	HEW-34300	HEW-41300	HEW-50300
 Digital Analogue Screw			
M1.6 w/hex. 1.20	HE-41215	HE-41215	HE-41215
 Impression Coping			
Open Tray (OT)	HEW-34700	HEW-41700	HEW-50700
 Healing Cap			
H 3mm	HEW-34403	HEW-41403	
H 4mm	HEW-34404	HEW-41404	
H 6mm	HEW-34406	HEW-41406	
 Screw			
M1.6 Hex 1.20 for Engaging	HEW-34200	HEW-34200	HEW-34200
M1.6 Hex 1.20 for Engaging DLC	HEW-34280	HEW-34280	HEW-34280
M1.6 Square 1.30	HEW-34201	HEW-34201	HEW-34201
M1.6 Gold for Engaging	HEW-34206	HEW-34206	HEW-34206
M1.6 Hex 1.20 for Non-Engaging		HEW-41201	HEW-41201
M1.6 Gold for Non-Engaging		HEW-41206	HEW-41206
M1.6 for Non-Engaging DLC		HEW-41280	HEW-41280
M1.6 Four-Lobed ACS	IBO 2201 225	IBO 2201 225	IBO 2201 225
 Castable			
Engaging	HEW-34001	HEW-41001	HEW-50001
Non-Engaging	HEW-34010	HEW-41010	HEW-50010
 CoCr Base Castable			
Engaging	HEW-34110	HEW-41110	HEW-50110
Non-Engaging	HEW-34100	HEW-41100	HEW-50100
 CoCr Base Angled Chimney			
17°	IBO 1102 013	IBO 1102 013	IBO 1102 011
30°	IBO 1102 014	IBO 1102 014	IBO 1102 012

	NP Ø3.4	RP Ø4.1	WP Ø5.0
 Temporary Abutment			
Engaging	HEW-34600	HEW-41600	HEW-50600
Non-Engaging	HEW-34610	HEW-41610	HEW-50610
 Straight Abutment			
Engaging	HEW-34500	HEW-41500	
 Scanbody			
Intraoral Titanium	IBO 2201 702	IBO 2202 702	IBO 2203 702
Laboratory Peek	HEW-34770	HEW-41770	HEW-50770
 AC 2G TiBase			
Engaging	IBO 2201 620	IBO 2202 620	IBO 2203 620
Non-Engaging	IBO 2201 621	IBO 2202 621	IBO 2203 621
 3G TiBase			
Engaging H 0.5mm	HEW-34741	HEW-41741	
Engaging H 1.5mm	HEW-34743	HEW-41743	
Non-Engaging H 0.5mm	HEW-34740	HEW-41740	
Non-Engaging H 1.5mm	HEW-34742	HEW-41742	
 Multiunit Uniblock Abutment			
H 1mm	HEW-34801	HEW-41801	HEW-50801
H 2mm	HEW-34802	HEW-41802	HEW-50802
H 3mm	HEW-34803	HEW-41803	HEW-50803
H 4mm	HEW-34804	HEW-41804	HEW-50804
 Multiunit Angled Abutment			
17° H 2mm	HEW-34852	HEW-41852	HEW-50852
17° H 4mm	HEW-34854	HEW-41854	HEW-50854
30° H 3mm	HEW-34863	HEW-41863	HEW-50863
30° H 5mm	HEW-34865	HEW-41865	HEW-50865
 Lock-Attach Abutment			
H 1mm	HEW-34901	HEW-41901	
H 2mm	HEW-34902	HEW-41902	
H 3mm	HEW-34903	HEW-41903	
H 4mm	HEW-34904	HEW-41904	
H 5mm	HEW-34905	HEW-41905	
H 6mm	HEW-34906	HEW-41906	

OMIS[®]

HEM CAD/CAM 1700
SEVEN[®]

CAD/CAM 4000
C1/V3[®]

Ibodontit S.L. has no connection with any of the brands listed above, which are the property of their respective trademark holders



Boiling olive oil at +215° at zoom x15



**MIS®
SEVEN®**

NP Ø3.3 / SP / WP



	NP Ø3.3	SP Ø3.75 Ø4.25	WP Ø5.0 Ø6.0
 Analogue			
	HEM-33300	HEM-42300	HEI-45300
 Digital Analogue Screw			
M1.6 w/hex. 1.20	HE-41215	HE-41215	HE-41215
 Impression Coping			
Open Tray (OT) Closed Tray (CT)	HEM-33700	HEI-35700 HEI-35710	HEI-45700
 Healing Cap			
H 2mm H 3mm H 4mm H 5mm H 6mm	HEM-33402 HEM-33403 HEM-33404 HEM-33405 HEM-33406	HEI-35402 HEI-35403 HEI-35404 HEI-35405	HEI-45403 HEI-45404 HEI-45405
 Screw			
M1.6 w/hex. 1.27 M1.6 w/hex. 1.27 DLC M1.8 w/hex. 1.27	HEM-33200 HEM-33280	HEM-42200	HEM-42200
M1.6 Four-Lobed ACS M1.8 Four-Lobed ACS	IBO 1701 225	IBO 1501 225	IBO 1501 225
 Calcinable			
Engaging Non-Engaging	HEM-33001 HEM-33010	HEM-42001 HEM-42010	HEI-45001 HEI-45010
 CoCr Base Castable			
Engaging Non-Engaging	HEM-33110 HEM-33100	HEI-35110 HEI-35100	HEI-45110 HEI-45100
 CoCr Base Angled Chimney			
17° 30°	IBO 1102 011 IBO 1102 012	IBO 1102 011 IBO 1102 012	IBO 1102 011 IBO 1102 012



Temporary Abutment

	NP Ø3.3	SP Ø3.75 Ø4.25	WP Ø5.0 Ø6.0
Engaging Non-Engaging	HEM-33600 HEM-33610	HEI-35600 HEI-35610	HEI-45600 HEI-45610



Straight / Angled Abutment

Straight Engaging		HEI-35505	
Ang. 15° Ang. 25°		HEI-35650 HEI-35651	



Scanbody

Intraoral Titanium Laboratory Peek	IBO 1701 702 HEM-33770	IBO 1501 702 HEI-35770	IBO 1502 702 HEI-45770
---------------------------------------	---------------------------	---------------------------	---------------------------



1G TiBase

Engaging Non-Engaging		HEI-35751 HEI-35750	HEI-45751 HEI-45750
--------------------------	--	------------------------	------------------------



AC 2G TiBase

Engaging H 0.5mm Engaging H 1.5mm Engaging H 2.5mm Non-Engaging H 0.5mm Non-Engaging H 1.5mm Non-Engaging H 2.5mm	IBO 1701 620 IBO 1701 621	IBO 1501 620 IBO 1501 622 IBO 1501 624 IBO 1501 621 IBO 1501 623 IBO 1501 625	IBO 1502 620 IBO 1502 622 IBO 1502 621 IBO 1502 623
--	----------------------------------	--	--



3G TiBase

Engaging H 0.5mm Engaging H 1.5mm Engaging H 2.5mm Non-Engaging H 0.5mm Non-Engaging H 1.5mm Non-Engaging H 2.5mm	HEM-33741 HEM-33743 HEM-33745 HEM-33740 HEM-33742 HEM-33744	HEI-35741 HEI-35743 HEI-35745 HEI-35740 HEI-35742 HEI-35744	HEI-45741 HEI-45743 HEI-45740 HEI-45742
--	--	--	--



Multiunit Uniblock Abutment

H 1mm H 2mm H 3mm H 4mm H 5mm	HEM-33801 HEM-33802 HEM-33803 HEM-33804	HEI-35801 HEI-35802 HEI-35803 HEI-35804 HEI-35805	HEI-45801 HEI-45802 HEI-45803 HEI-45804 HEI-45805
---	--	---	---



Multiunit Angled Abutment

17° H 2mm 17° H 3mm 17° H 4mm 30° H 4mm 30° H 5mm 30° H 6mm		HEI-35852 HEI-35853 HEI-35854 HEI-35864 HEI-35865 HEI-35866	HEI-45852 HEI-45853 HEI-45854 HEI-45864 HEI-45865 HEI-45866
--	--	--	--



Lock-Attach Abutment

	NP Ø3.3	SP Ø3.75 Ø4.25	WP Ø5.0 Ø6.0
H 1mm	HEM-33901	HEI-35901	HEI-45901
H 2mm	HEM-33902	HEI-35902	HEI-45902
H 3mm	HEM-33903	HEI-35903	HEI-45903
H 4mm	HEM-33904	HEI-35904	HEI-45904
H 5mm	HEM-33905	HEI-35905	HEI-45905
H 6mm	HEM-33906	HEI-35906	HEI-45906



Angled H 1.5mm	HEI-35951
Angled H 3mm	HEI-35953



Scanbody

Intraoral Titanium IBO 4002 702



AC 2G TiBase

Engaging H 1mm IBO 4002 620
Non-Engaging H 1mm IBO 4002 621



3G TiBase

Engaging H 0.7mm IBO 4002 601
Engaging H 1.5mm IBO 4002 603
Engaging H 2.5mm IBO 4002 605
Non-Engaging H 0.7mm IBO 4002 600
Non-Engaging H 1.5mm IBO 4002 602
Non-Engaging H 2.5mm IBO 4002 604



Multiunit Uniblock Abutment

H 1mm IBO 4002 801
H 2mm IBO 4002 802
H 3mm IBO 4002 803
H 4mm IBO 4002 804



Lock-Attach Abutment

H 1mm IBO 4002 901
H 2mm IBO 4002 902
H 3mm IBO 4002 903
H 4mm IBO 4002 904

SP Ø 3.75 / 4.2



Analogue

IBO 4002 300



Digital Analogue Screw

M1.6 w/hex. 1.20 HE-41215



Impression Coping

Open Tray (OT) IBO 4002 350



Healing Cap

H 2mm IBO 4002 402
H 3mm IBO 4002 403
H 4mm IBO 4002 404
H 5mm IBO 4002 405



Screw

M1.8 w/hex. 1.20 IBO 4002 200

M1.8 Four-Lobed ACS IBO 1501 225



CoCr Base Castable

Engaging IBO 4002 110
Non-Engaging IBO 4002 100



CoCr Base Angled Chimney

17° IBO 1102 011
30° IBO 1102 012



Temporary Abutment

Engaging IBO 4002 550
Non-Engaging IBO 4002 555

SWEDEN & MARTINA®

HES CAD/CAM 2700
PREMIUM KOHNO®

Ibodentit S.L. has no connection with any of the brands listed above, which are the property of their respective trademark holders











Ceylon fish owl plumage at x50 zoom



SWEDEN & MARTINA® PREMIUM KHONO®

Ø3.3 / Ø3.8 / Ø4.25 / Ø5.0



	Ø3.3	Ø3.8	Ø4.25	Ø5.0
 Analogue				
	HES-33300	HES-38300	HES-43300	HES-50300
 Digital Analogue Screw				
M1.6 w/hex. 1.20	HE-41215	HE-41215	HE-41215	HE-41215
 Impression Coping				
Open Tray (OT)	HES-33700	HES-38700	HES-43700	
 Healing Cap				
H 3mm	HES-33403	HES-38403	HES-43403	
H 5mm	HES-33405	HES-38405	HES-43405	
H 6mm		HES-38406	HES-43406	
 Screw				
M1.8 w/hex 1.27	HES-38200	HES-38200		
M1.8 w/hex 1.27 DLC	HES-38280	HES-38280		
M2 w/hex 1.27			HES-43200	HES-43200
M2 w/hex 1.27 DLC			HES-43280	HES-43280
M1.8 Four-Lobed ACS	IBO 2702 225	IBO 2702 225		
M2 Four-Lobed ACS			IBO 2703 225	IBO 2703 225
 Castable				
Engaging	HES-33001	HES-38001	HES-43001	HES-50001
Non-Engaging	HES-33010	HES-38010	HES-43010	HES-50010
 CoCr Base Castable				
Engaging	HES-33110	HES-38110	HES-43110	
Non-Engaging	HES-33100	HES-38100	HES-43100	
 CoCr Base Angled Chimney				
17°	IBO 1102 011	IBO 1102 011	IBO 1102 011	
30°	IBO 1102 012	IBO 1102 012	IBO 1102 012	



Temporary Abutment

	Ø3.3	Ø3.8	Ø4.25	Ø5.0
Engaging	HES-33600	HES-38600	HES-43600	
Non-Engaging	HES-33610	HES-38610	HES-43610	



Straight Abutment

	Ø3.3	Ø3.8	Ø4.25	Ø5.0
Engaging		HES-38500	HES-43500	HES-50500



Scanbody

	Ø3.3	Ø3.8	Ø4.25	Ø5.0
Intraoral Titanium	IBO 2701 702	IBO 2702 702	IBO 2703 702	IBO 2704 702
Laboratory Peek	HES-33770	HES-38770	HES-43770	



AC 2G TiBase

	Ø3.3	Ø3.8	Ø4.25	Ø5.0
Engaging	IBO 2701 620	IBO 2702 620	IBO 2703 620	
Non-Engaging	IBO 2701 621	IBO 2702 621	IBO 2703 621	



3G TiBase

	Ø3.3	Ø3.8	Ø4.25	Ø5.0
Engaging H 0.5mm	HES-33741	HES-38741	HES-43741	
Engaging H 1.5mm	HES-33743	HES-38743	HES-43743	
Non-Engaging H 0.5mm	HES-33740	HES-38740	HES-43740	
Non-Engaging H 1.5mm	HES-33742	HES-38742	HES-33742	



Multiunit Uniblock Abutment

	Ø3.3	Ø3.8	Ø4.25	Ø5.0
H 1mm	HES-33801	HES-38801	HES-43801	
H 2mm	HES-33802	HES-38802	HES-43802	
H 3mm	HES-33803	HES-38803	HES-43803	
H 4mm	HES-33804	HES-38804	HES-43804	



Multiunit Angled Abutment

	Ø3.3	Ø3.8	Ø4.25	Ø5.0
17° H 2.5mm	HES-33852	HES-38852	HES-43852	
17° H 3.5mm	HES-33853	HES-38853	HES-43853	
30° H 3.5mm	HES-33863	HES-38863	HES-43863	
30° H 4.5mm	HES-33864	HES-38864	HES-43864	



Lock-Attach Abutment

	Ø3.3	Ø3.8	Ø4.25	Ø5.0
H 1mm	HES-33901	HES-38901	HES-43901	
H 2mm	HES-33902	HES-38902	HES-43902	
H 3mm	HES-33903	HES-38903	HES-43903	
H 4mm	HES-33904	HES-38904	HES-43904	

KLOCKNER®

HEV CAD/CAM 2300
SK2-NK2®

HEV CAD/CAM 2400
ESSENTIAL®

CAD/CAM 4100
VEGA®

Ibodontit S.L. has no connection with any of the brands listed above, which are the property of their respective trademark holders



Basketball ball at x15 zoom



KLOCKNER® SK2-NK2®

Ø4.2



Scanbody

Intraoral Titanium
Laboratory Peek

SK2 - NK2 Ø4.2

IBO 2301702
HEV-42770



1G TiBase

Engaging
Non-Engaging

HEV-42751
HEV-42750



AC 2G TiBase

Engaging
Non-Engaging

IBO 2301 620
IBO 2301 621



Lock-Attach Abutment

H 2.5mm
H 3.5mm
H 4.5mm
H 5.5mm

HEV-42902
HEV-42903
HEV-42904
HEV-42905

SK2 - NK2 Ø4.2



Analogue

HEV-42300



Digital Analogue Screw

M1.6 w/hex. 1.20

HE-41215



Impression Coping

Open Tray (OT)
Closed Tray (CT)

HEV-42700
HEV-42710



Healing Cap

H 4.5mm
H 5.5mm

HEV-42404
HEV-42505



Screw

M1.8 w/hex. 1.70
M1.8 Crossdrive

HEV-42200
HEV-42201

M1.8 Four-Lobed ACS

IBO 2301 225



Castable

Engaging
Non-Engaging

HEV-42001
HEV-42010



CoCr Base Castable

Engaging
Non-Engaging

HEV-42110
HEV-42100



Straight Abutment

Engaging
Non-Engaging

HEV-42500
HEV-42550

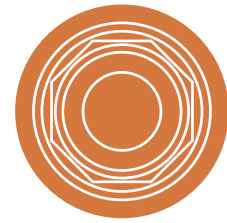

KLOCKNER® ESSENTIAL®

Ø4.5

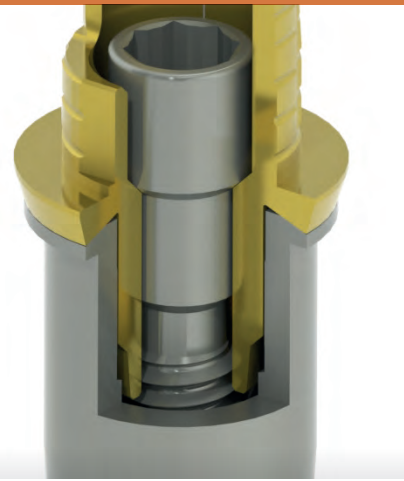

RP Ø4.5

	Analogue	HEV-45300
	Digital Analogue Screw M1.6 w/hex. 1.20	HE-41215
	Screw M1.8 w/Star-head	HEV-45200
	M1.8 Four-Lobed ACS	IBO 2401 225
	Castable Engaging Non-Engaging	HEV-45001 HEV-45010
	CoCr Base Castable Engaging Non-Engaging	HEV-45110 HEV-45100
	Scanbody Intraoral Titanium Laboratory Peek	IBO 2401 702 HEV-45770
	AC 2G TiBase Engaging Non-Engaging	IBO 2401 620 IBO 2401 621

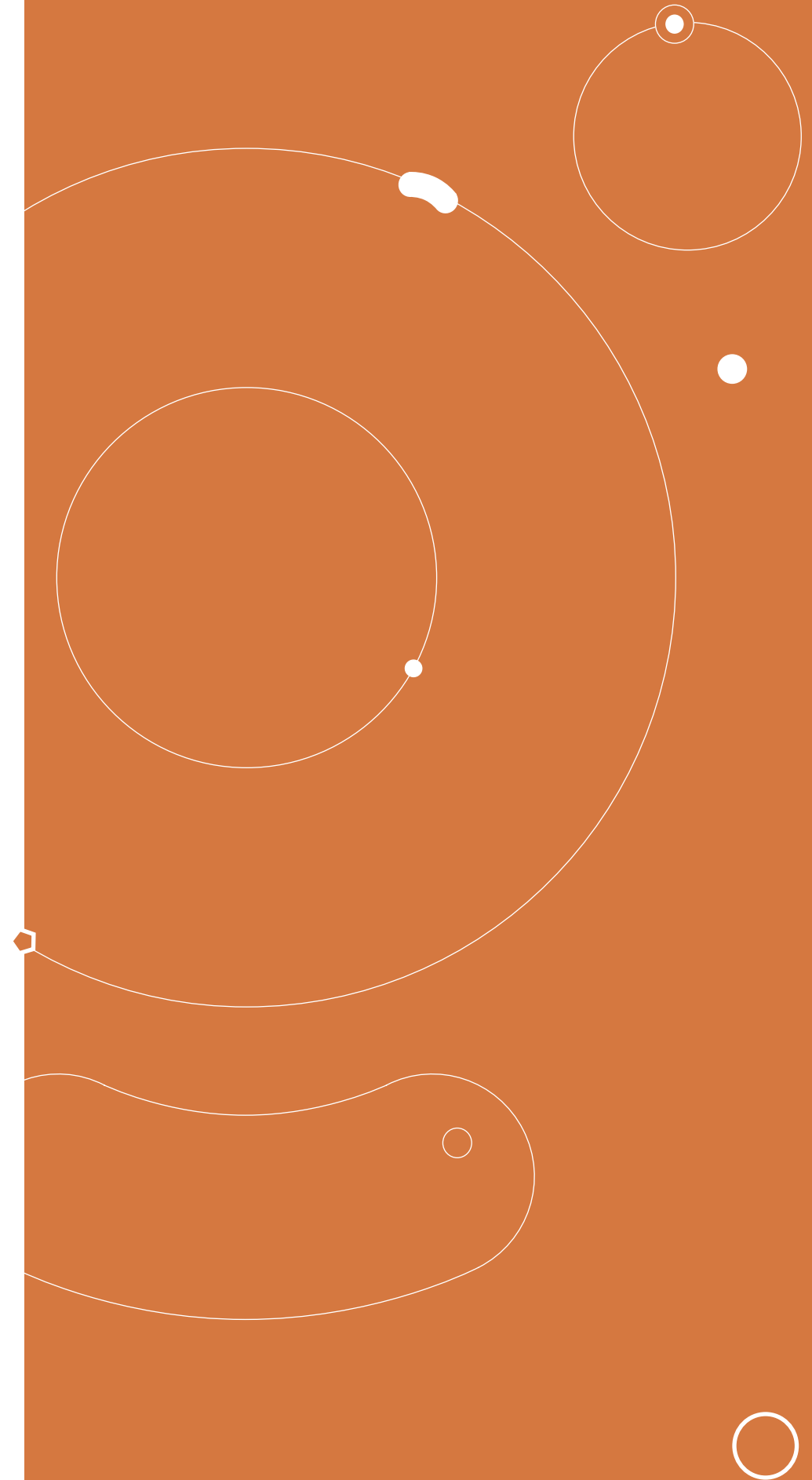



Ø3.5 / Ø4.0 / Ø4.5



AC 2G TiBase

Engaging H 0.5mm
Non-Engaging H 0.5mm

Ø3.5

IBO 4101 620
IBO 4101 621

Ø4.0 - 4.5

IBO 4102 620
IBO 4102 621



3G TiBase

Engaging H 0.7mm
Engaging H 1.5mm
Engaging H 2.5mm
Non-Engaging H 0.7mm
Non-Engaging H 1.5mm
Non-Engaging H 2.5mm

IBO 4101 601
IBO 4101 603
IBO 4101 605
IBO 4101 600
IBO 4101 602
IBO 4101 604

IBO 4102 601
IBO 4102 603
IBO 4102 605
IBO 4102 600
IBO 4102 602
IBO 4102 604



Multiunit Uniblock Abutment

H 1.5mm
H 2.5mm
H 3.5mm
H 4.5mm

IBO 4101 801
IBO 4101 802
IBO 4101 803
IBO 4101 804

IBO 4102 801
IBO 4102 802
IBO 4102 803
IBO 4102 804



Multiunit Angled Abutment

17° H 2.5mm
30° H 3.5mm

IBO 4101 852
IBO 4101 863

IBO 4102 852
IBO 4102 863



Lock-Attach Abutment

H 1mm
H 2mm
H 3mm
H 4mm
H 5mm

IBO 4101 901
IBO 4101 902
IBO 4101 903
IBO 4101 904
IBO 4101 905

IBO 4102 901
IBO 4102 902
IBO 4102 903
IBO 4102 904
IBO 4102 905

	Ø3.5	Ø4.0 - 4.5
 Analogue		
	IBO 4101 300	IBO 4102 300
 Digital Analogue Screw		
M1.6 w/hex. 1.20	HE-41215	HE-41215
 Impression Coping		
Open Tray (OT)	IBO 4101 350	IBO 4102 350
 Screw		
M1.6 w/Star-head M w/Star-head	IBO 4101 200	IBO 4102 200
M1.8 Four-Lobed ACS M Four-Lobed ACS	IBO 4101 225	IBO4102 225
 CoCr Base Castable		
Engaging Non-Engaging	IBO 4101 110 IBO 4101 100	IBO 4102 110 IBO 4102 100
 CoCr Base Angled Chimney		
17° 30°	IBO 1102 011 IBO 1102 012	IBO 1102 011
 Temporary Abutment		
Engaging Non-Engaging	IBO 4101 550 IBO 4101 555	IBO 4102 550 IBO 4102 555
 Scanbody		
Intraoral Titanium	IBO 4101 702	IBO 4102 702



Siberian cat tongue zoomed x200

BIOHORIZONS[®]

HEI CAD/CAM 1600
TAPERED INTERNAL[®]







Ibodontit S.L. has no connection with any of the brands listed above, which are the property of their respective trademark holders



BIOHORIZONS® TAPERED INTERNAL®

Ø3.0 / Ø3.5 / Ø4.5



	Ø3.0	Ø3.5	Ø4.5
 Analogue			
	IBO 1601 300	HEI-35300	HEI-45300
 Digital Analogue Screw			
M1.6 w/hex. 1.20	HE-41215	HE-41215	HE-41215
 Impression Coping			
Open Tray (OT)	IBO 1601 350	HEI-35700	HEI-45700
Closed Tray (CT)		HEI-35710	
 Transfer Screw			
Impression Coping OT		HEI-35701	
Impression Coping CT		HEI-35711	
 Healing Cap			
H 2mm		HEI-35402	
H 3mm	IBO 1601 403	HEI-35403	HEI-45403
H 4mm		HEI-35404	HEI-45404
H 5mm	IBO 1601 405	HEI-35405	HEI-45405
 Screw			
M1.8 w/hex. 1.27	IBO 1601 200	HEI-35201	HEI-35201
M1.8 w/hex. 1.27 DLC		HEI-35280	HEI-35280
M1.8 Four-Lobed ACS	IBO 1501 225	IBO 1501 225	IBO 1501 225
 Castable			
Engaging Ø3.5 plat 3.7		HEI-35001	HEI-45001
Non-Engaging Ø3.5 plat 3.7		HEI-35010	HEI-45010

	Ø3.0	Ø3.5	Ø4.5
 CoCr Base Castable			
Engaging	IBO 1601 110	HEI-35110	HEI-45110
Non-Engaging	IBO 1601 100	HEI-35100	HEI-45100
 CoCr Base Angled Chimney			
17°	IBO 1102 011	IBO 1102 011	IBO 1102 011
30°	IBO 1102 012	IBO 1102 012	IBO 1102 012
 Temporary Abutment			
Engaging	IBO 1601 550	HEI-35600	HEI-45600
Non-Engaging	IBO 1601 555	HEI-35610	HEI-45610
 Scanbody			
Intraoral Titanium	IBO 1601 702	IBO 1501 702	IBO 1502 702
Laboratory Peek		HEI-35770	HEI-45770
 1G TiBase			
Engaging		HEI-35751	HEI-45751
Non-Engaging		HEI-35750	HEI-45750
 AC 2G TiBase			
Engaging H 0.5mm		IBO 1501 620	IBO 1502 620
Engaging H 1.5mm		IBO 1501 622	IBO 1502 622
Engaging H 2.5mm		IBO 1501 624	
Non-Engaging H 0.5mm		IBO 1501 621	IBO 1502 621
Non-Engaging H 1.5mm		IBO 1501 623	IBO 1502 623
Non-Engaging H 2.5mm		IBO 1501 625	
 3G TiBase			
Engaging H 0.5mm	IBO 1601 601	HEI-35741	HEI-45741
Engaging H 1.5mm	IBO 1601 603	HEI-35743	HEI-45743
Engaging H 2.5mm	IBO 1601 605	HEI-35745	
Non-Engaging H 0.5mm	IBO 1601 600	HEI-35740	HEI-45740
Non-Engaging H 1.5mm	IBO 1601 602	HEI-35742	HEI-45742
Non-Engaging H 2.5mm	IBO 1601 604	HEI-35744	
 Multiunit Uniblock Abutment			
H 1mm		HEI-35801	HEI-45801
H 2mm		HEI-35802	HEI-45802
H 3mm		HEI-35803	HEI-45803
H 4mm		HEI-35804	HEI-45804
H 5mm		HEI-35805	HEI-45805

Ø3.0 Ø3.5 Ø4.5



Multiunit Angled Abutment

17° H 2mm	HEI-35852	HEI-45852
17° H 3mm	HEI-35853	HEI-45853
17° H 4mm	HEI-35854	HEI-45854
30° H 4mm	HEI-35864	HEI-45864
30° H 5mm	HEI-35865	HEI-45865
30° H 6mm	HEI-35866	HEI-45866



Pilar Lock-Attach

H 1mm	HEI-35901	HEI-45901
H 2mm	HEI-35902	HEI-45902
H 3mm	HEI-35903	HEI-45903
H 4mm	HEI-35904	HEI-45904
H 5mm	HEI-35905	HEI-45905
H 6mm	HEI-35906	HEI-45906



Angled H 1.5mm
Angled H 3mm

HEI-35951
HEI-35953

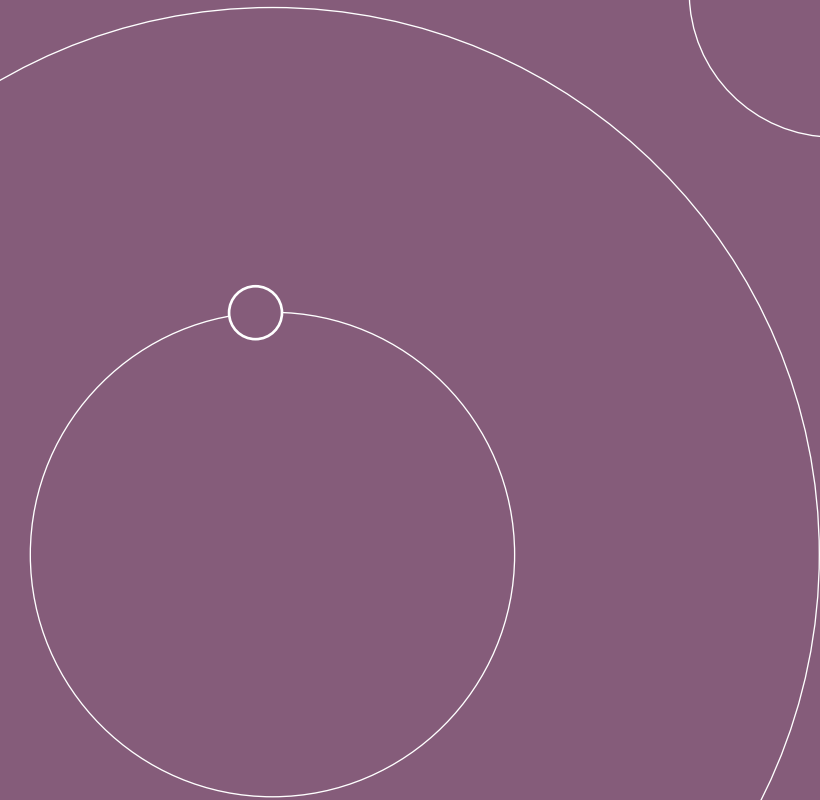
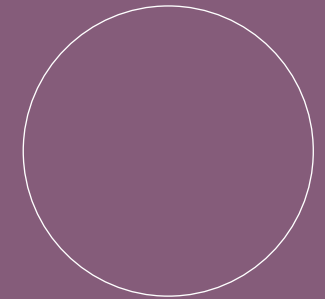
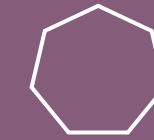

DENTSPLY®

CAD/CAM 3100
FRIADENT XIVE®

CAD/CAM 3500
ANKYLOS C/X®

Ibodontit S.L. has no connection with any of the brands listed above, which are the property of their respective trademark holders



Sugar crystals at high zoom x100

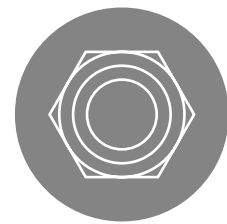

DENTSPLY® FRIADENT XIVE®

Ø3.4 / Ø3.8 / Ø4.5



AC 2G TiBase

	Ø3.4	Ø3.8	Ø4.5
Engaging	IBO 3101 620	IBO 3102 620	IBO 3103 620
Non-Engaging	IBO 3101 621	IBO 3102 621	IBO 3103 621



3G TiBase

	Ø3.4	Ø3.8	Ø4.5
Engaging H 0.5mm		IBO 3102 601	
Engaging H 1.5mm		IBO 3102 603	
Non-Engaging H 0.5mm		IBO 3102 600	
Non-Engaging H 1.5mm		IBO 3102 602	



Multiunit Uniblock Abutment

	Ø3.4	Ø3.8	Ø4.5
H 1mm	IBO 3101 801	IBO 3102 801	IBO 3103 801
H 2mm	IBO 3101 802	IBO 3102 802	IBO 3103 802
H 3mm	IBO 3101 803	IBO 3102 803	IBO 3103 803
H 4mm	IBO 3101 804	IBO 3102 804	IBO 3103 804



Lock-Attach Abutment

	Ø3.4	Ø3.8	Ø4.5
H 1mm	IBO 3101 901	IBO 3102 901	IBO 3103 901
H 2mm	IBO 3101 902	IBO 3102 902	IBO 3103 902
H 3mm	IBO 3101 903	IBO 3102 903	IBO 3103 903
H 4mm	IBO 3101 904	IBO 3102 904	IBO 3103 904

	Ø3.4	Ø3.8	Ø4.5
Analogue			
	IBO 3101 300	IBO 3102 300	IBO 3103 300
Digital Analogue Screw			
M1.6 w/hex. 1.20	HE-41215	HE-41215	HE-41215
Impression Coping			
Open Tray (OT)	IBO 3101 350	IBO 3102 350	IBO 3103 350
Healing Cap			
H 3mm	IBO 3101 403	IBO 3102 403	IBO 3102 403
H 5mm	IBO 3101 405	IBO 3102 405	IBO 3102 405
Screw			
M1.6 w/hex. 1.20	IBO 3102 200	IBO 3102 200	IBO 3102 200
M1.6 w/hex. 1.20 DLC	IBO 3102 280	IBO 3102 280	IBO 3102 280
M1.6 Four-Lobed ACS	IBO 3102 225	IBO 3102 225	IBO 3102 225
Castable			
Engaging	IBO 3101 001	IBO 3102 001	IBO 3103 001
Non-Engaging	IBO 3101 010	IBO 3102 010	IBO 3103 010
CoCr Base Castable			
Engaging	IBO 3101 110	IBO 3102 110	IBO 3103 110
Non-Engaging	IBO 3101 100	IBO 3102 100	IBO 3103 100
Scanbody			
Intraoral Titanium	IBO 3101 702	IBO 3102 702	IBO 3103 702
Laboratory Peek	IBO 3101 700	IBO 3102 700	IBO 3103 700

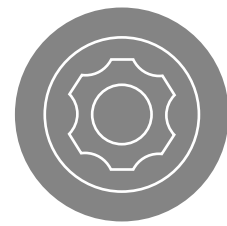

DENTSPLY® ANKYLOS®

C/X

Ø3.5 / 4.5 / 5.5 / 7.0



Analogue

IBO 3502 300



Digital Analogue Screw

M1.6 w/hex. 1.20

HE-41215



Impression Coping

Open Tray (OT)

IBO 3502 350



Healing Cap

H 2mm
H 3.5mm
H 5mmIBO 3402 402
IBO 3402 403
IBO 3402 404

Screw

M1.8 for Non-Engaging

IBO 3502 200



Castable

Engaging
Non-EngagingIBO 3502 001
IBO 3502 010

CoCr Base Castable

Engaging
Non-EngagingIBO 3502 110
IBO 3502 100

Temporary Abutment

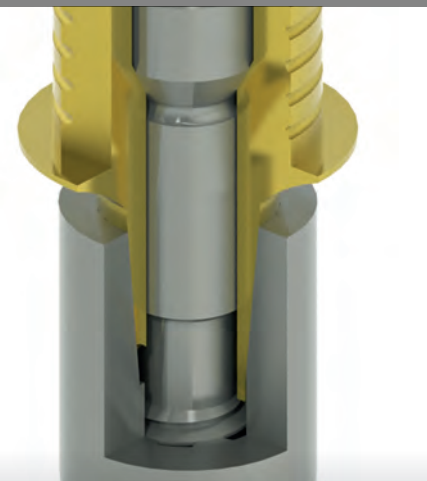
Engaging
Non-EngagingIBO 3502 550
IBO 3502 555

Scanbody

Intraoral Titanium
Laboratory PeekIBO 3502 702
IBO 3502 700

AC 2G TiBase

Engaging H 1mm
Non-Engaging H 1mmIBO 3502 620
IBO 3502 621

Multiunit Uniblock Abutment

H 1.5mm
H 2.5mm
H 3.5mm
H 4.5mmIBO 3402 801
IBO 3402 802
IBO 3402 803
IBO 3402 804

Lock-Attach Abutment

H 2mm
H 3mm
H 4mm
H 5mmIBO 3402 902
IBO 3402 903
IBO 3402 904
IBO 3402 905

BTI[®]

HEB CAD/CAM 2600
EXTERNAL HEX.[®]

HEB CAD/CAM 2500
INTERNAL[®]

Ibodontit S.L. has no connection with any of the brands listed above, which are the property of their respective trademark holders





African wild elephant skin at x30 zoom

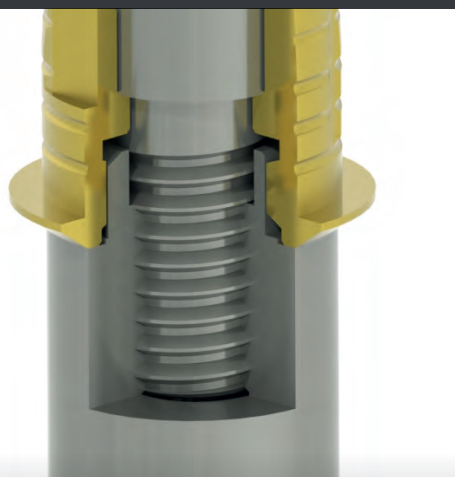

BTI® EXTERNAL HEX.®

Ø3.5 / Ø4.1



	NP Ø3.5	RP Ø4.1
	Analogue	
	HEB-35300	HE-41300
	Digital Analogue Screw	
M1.6 w/hex. 1.20	HE-41215	HE-41215
	Impression Coping	
Open Tray (OT) Closed Tray (CT)		HE-41700 HE-41710
	Healing Cap	
H 2mm H 3mm H 4mm H 5mm		HE-41402 HE-41403 HE-41404 HE-41405
	Screw	
M2 hex. 1.20 M2 hex. 1.20 DLC	HEB-35200 HE-41280	HE-41200 HE-41280
M2 Four-Lobed ACS	IBO 1102 225	IBO 1102 225
	Castable	
Engaging Non-Engaging	HEB-35001 HEB-35010	HE-41001 HE-41010
	CoCr Base Castable	
Engaging Non-Engaging		HE-41110 HE-41100
	CoCr Base Angled Chimney	
17° 30°		IBO 1102 011 IBO 1102 012



Scanbody

Intraoral Titanium
Laboratory Peek

NP Ø3.5

IBO 2601 702
HEB-35770

RP Ø4.1

IBO 1102 702
HE-41770



1G TiBase

Engaging
Non-Engaging

HE-41751
HE-41750



AC 2G TiBase

Engaging H 0.5mm
Engaging H 1.5mm
Engaging H 2.5mm
Non-Engaging H 0.5mm
Non-Engaging H 1.5mm
Non-Engaging H 2.5mm

IBO 2601 620

IBO 2601 621

IBO 1102 620
IBO 1102 622
IBO 1102 624
IBO 1102 621
IBO 1102 623
IBO 1102 625



3G TiBase3G

Engaging H 0.5mm
Engaging H 1.5mm
Engaging H 2.5mm
Non-Engaging H 0.5mm
Non-Engaging H 1.5mm
Non-Engaging H 2.5mm

HE-41741
HE-41743
HE-41745
HE-41740
HE-41742
HE-41744



Multiunit Uniblock Abutment

H 1mm
H 2mm
H 3mm
H 4mm
H 5mm

HE-48801
HE-48802
HE-48803
HE-48804
HE-48805



Multiunit Angled Abutment

17° H 2mm
17° H 3mm
17° H 4mm
30° H 3mm
30° H 4mm
30° H 5mm

HE-48852
HE-48853
HE-48854
HE-48863
HE-48864
HE-48865



Lock-Attach Abutment

H 0.73mm
H 2mm
H 3mm
H 4mm
H 5mm
H 6mm

HE-41901
HE-41902
HE-41903
HE-41904
HE-41905
HE-41906



Angled H 1.5mm
Angled H 3mm

HE-41951
HE-41953



BTI®
INTERNAL®

Ø4.1 UNIVERSAL / Ø5.5 WIDE



	RP Ø4.1	WP Ø5.5
Analogue		
Multi IM	HEB-41300 HEB-41301	HEB-55300
Digital Analogue Screw		
M1.6 w/hex. 1.20	HE-41215	HE-41215
Impression Coping		
Open Tray (OT) Open Tray Multi IM (OT)	HEB-41700 HEB-41701	HEB-55700
Healing Cap		
H 2mm	HEB-41402	
H 3mm	HEB-41403	
H 4mm	HEB-41404	
H 5mm	HEB-41405	
H 6mm	HEB-41406	
H 8mm	HEB-41408	
Multi IM	HEB-41420	
Screw		
M1.8 w/hex. 1.20	HEB-41200	HEB-41200
M1.8 w/hex. 1.20 Gold	HEB-41206	HEB-41206
M1.8 Unigrip DLC	HEB-41280	HEB-41280
Multi IM	HEB-41208	
M1.8 Four-Lobed ACS	IBO 2501 225	IBO 2501 225
Four-Lobed ACS Multi IM	IBO 2501 226	
Castable		
Engaging	HEB-41001	HEB-55001
Non-Engaging	HEB-41010	HEB-55010

	RP Ø4.1	WP Ø5.5
CoCr Base Castable		
Engaging	HEB-41100	HEB-55100
Non-Engaging	HEB-41110	HEB-55110
CoCr Base Angled Chimney		
17°	IBO 1102 013	IBO 1102 011
30°	IBO 1102 014	IBO 1102 012
Temporary Abutment		
Engaging	HEB-41600	HEB-55600
Non-Engaging	HEB-41610	HEB-55610
Scanbody		
Intraoral Titanium	IBO 2501 702	IBO 2502 702
Laboratory Peek	HEB-41770	HEB-55770
Intraoral Multi IM Titanium	IBO 2501 703	
AC 2G TiBase		
Engaging	IBO 2501 620	IBO 2502 620
Non-Engaging	IBO 2501 621	IBO 2502 621
3G TiBase		
Engaging H 0.5mm	HEB-41741	
Engaging H 1.5mm	HEB-41743	
Non-Engaging H 0.5mm	HEB-41740	
Non-Engaging H 1.5mm	HEB-41742	
Multi IM	HEB-41758	
Multiunit Uniblock Abutment		
H 0mm	HEB-41800	
H 1mm	HEB-41801	HEB-55801
H 2mm	HEB-41802	HEB-55802
H 3mm	HEB-41803	HEB-55803
H 4mm	HEB-41804	HEB-55804
H 5mm	HEB-41805	
Multiunit Angled Abutment		
17° H 2mm	HEB-41852	
17° H 3mm	HEB-41853	
30° H 3mm	HEB-41863	
30° H 4mm	HEB-41864	
Lock-Attach Abutment		
H 1mm	HEB-41901	
H 2mm	HEB-41902	
H 3mm	HEB-41903	
H 4mm	HEB-41904	
H 5mm	HEB-41905	
H 6mm	HEB-41906	

MICRODENT®

CAD/CAM 3300
SYSTEM®

Ibodontit S.L. has no connection with any of the brands listed above, which are the property of their respective trademark holders



Cork oak bark at zoom x30

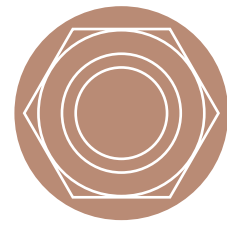

MICRODENT® SYSTEM®

Ø4.2 / Ø5.1



Scanbody

	Ø4.2	Ø5.1
Intraoral Titanium	IBO 3302 702	



AC 2G TiBase

Engaging	IBO 3302 620	
Non-Engaging	IBO 3302 621	



Multiunit Uniblock Abutment

H 1.5mm	IBO 3302 801	
---------	--------------	--



Lock-Attach Abutment

H 1mm	IBO 3302 901	IBO 3303 901
H 2mm	IBO 3302 902	IBO 3303 902
H 3mm	IBO 3302 903	IBO 3303 903
H 4mm	IBO 3302 904	IBO 3303 904



Analogue

	Ø4.2	Ø5.1
	IBO 3302 300	IBO 3303 300



Digital Analogue Screw

M1.6 w/hex. 1.20	HE-41215	HE-41215
------------------	----------	----------



Impression Coping

Open Tray (OT)	IBO 3302 350	IBO 3303 350
----------------	--------------	--------------



Healing Cap

H 3mm		IBO 3303 403
H 5mm	IBO 3302 405	IBO 3303 405



Screw

M2 w/hex. 1.75	IBO 3302 201	IBO 3302 201
M2 w/hex. 1.20	HE-41200	HE-41200

M2 Four-Lobed ACS	IBO 1102 225	IBO 1102 225
-------------------	--------------	--------------



Castable

Engaging	IBO 3302 001	IBO 3303 001
Non-Engaging	IBO 3302 010	IBO 3303 010



CoCr Base Castable

Engaging	IBO 3302 110	
Non-Engaging	IBO 3302 100	



CoCr Base Angled Chimney

17°	IBO 1102 011	
30°	IBO 1102 012	

PHIBO®

HPH CAD/CAM 2900
TSH®

Ibodontit S.L. has no connection with any of the brands listed above, which are the property of their respective trademark holders



Rusty wrought iron chains at x40 zoom

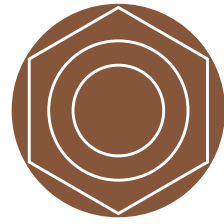

PHIBO®
TSH®

S2 / S3 - S4



	S2 Ø3.3	S3-S4 Ø3.75 Ø4.1
Analogue		
	HPH-33300	HE-41300
Digital Analogue Screw		
 M1.6 w/hex. 1.20	HE-41215	HE-41215
Impression Coping		
 Open Tray (OT) Closed Tray (CT)	HPH-33700	HE-41700 HE-41710
Healing Cap		
 H 2mm H 3mm H 4mm H 5mm		HE-41402 HE-41403 HE-41404 HE-41405
Screw		
 M1.8 w/hex. 1.25 M2 w/hex. 1.20 M2 w/hex. 1.20 DLC M2 w/hex. 1.25	HPH-33200	HE-41200 HE-41280 HE-41203
 M1.8 Four-Lobed ACS M2 Four-Lobed ACS	IBO 2901 225	IBO 1102 225
Castable		
 Engaging Non-Engaging	HPH-33001 HPH-33010	HE-41001 HE-41010
CoCr Base Castable		
 Engaging Non-Engaging	HPH-33110 HPH-33100	HE-41110 HE-41100
CoCr Base Angled Chimney		
 17° 30°	IBO 1102 011	IBO 1102 011 IBO 1102 012

	S2 Ø3.3	S3-S4 Ø3.75 Ø4.1
Scanbody		
 Intraoral Titanium Laboratory Peek	IBO 2901 702	IBO 1102 702 HE-41770
1G TiBase		
 Engaging Non-Engaging		HE-41751 HE-41750
AC 2G TiBase		
 Engaging H 0.5mm Engaging H 1.5mm Engaging H 2.5mm Non-Engaging H 0.5mm Non-Engaging H 1.5mm Non-Engaging H 2.5mm		IBO 1102 620 IBO 1102 622 IBO 1102 624 IBO 1102 621 IBO 1102 623 IBO 1102 625
3G TiBase		
 Engaging H 0.5mm Engaging H 1.5mm Engaging H 2.5mm Non-Engaging H 0.5mm Non-Engaging H 1.5mm Non-Engaging H 2.5mm	HPH-33741 HPH-33740	HE-41741 HE-41743 HE-41745 HE-41740 HE-41742 HE-41744
Multiunit Uniblock Abutment		
 H 1mm H 2mm H 3mm H 4mm H 5mm H 7mm w/ Screw		HE-48801 HE-48802 HE-48803 HE-48804 HE-48805 HE-48807
Multiunit Angled Abutment		
 17° H 2mm 17° H 3mm 17° H 4mm 30° H 3mm 30° H 4mm 30° H 5mm		HE-48852 HE-48853 HE-48854 HE-48863 HE-48864 HE-48865
Lock-Attach Abutment		
 H 0.73mm H 1mm H 2mm H 3mm H 4mm H 5mm H 6mm	HPH-33901 HPH-33902 HPH-33903 HPH-33904	HE-41901 HE-41902 HE-41903 HE-41904 HE-41905 HE-41906
 Angled H 1.5mm Angled H 3mm		HE-41951 HE-41953

NEODENT®

CAD/CAM 3400
CM CONO MORSE®

CAD/CAM 3600
GM GRAND MORSE®

Ibodontit S.L. has no connection with any of the brands listed above, which are the property of their respective trademark holders



Pine wood zoomed x15

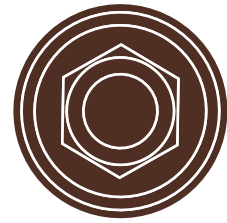

NEODENT® CM CONO MORSE®

Ø3.5

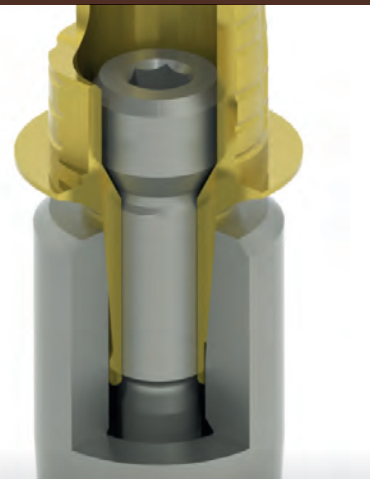

		Ø3.5
	Analogue	
		IBO 3402 300
	Digital Analogue Screw	
	M1.6 w/hex. 1.20	HE-41215
	Impression Coping	
	Open Tray (OT)	IBO 3402 350
	Healing Cap	
	H 2mm	IBO 3402 402
	H 3.5mm	IBO 3402 403
	H 5mm	IBO 3402 404
	Screw	
	M1.8 w/hex. 0.90	IBO 3402 200
	M1.8 w/hex. 0.90 DLC	IBO 3402 280
	M1.8 Four-Lobed ACS	IBO 3402 225
	Castable	
	Engaging	IBO 3402 001
	Non-Engaging	IBO 3402 010
	CoCr Base Castable	
	Engaging	IBO 3402 110
	Non-Engaging	IBO 3402 100
	CoCr Base Angled Chimney	
	17°	IBO 1102 013
	30°	IBO 1102 014

Ø3.5

	Temporary Abutment	
	Engaging	IBO 3402 550
	Non-Engaging	IBO 3402 555
	Scanbody	
	Intraoral Titanium	IBO 3402 702
	Laboratory Peek	IBO 3402 700
	AC 2G TiBase	
	Engaging	IBO 3402 620
	Non-Engaging	IBO 3402 621
	Multiunit Uniblock Abutment	
	H 1.5mm	IBO 3402 801
	H 2.5mm	IBO 3402 802
	H 3.5mm	IBO 3402 803
	H 4.5mm	IBO 3402 804
	Multiunit Angled Abutment	
	17° H 2.5mm	IBO 3402 852
	17° H 3.5mm	IBO 3402 853
	30° H 3.5mm	IBO 3402 864
	30° H 4.5mm	IBO 3402 865
	Lock-Attach Abutment	
	H 2mm	IBO 3402 902
	H 3mm	IBO 3402 903
	H 4mm	IBO 3402 904
	H 5mm	IBO 3402 905



NEODENT® GM GRAND MORSE®

Ø3.5 / Ø3.75 / Ø4.0 / Ø4.3 / Ø5.0 / Ø6.0

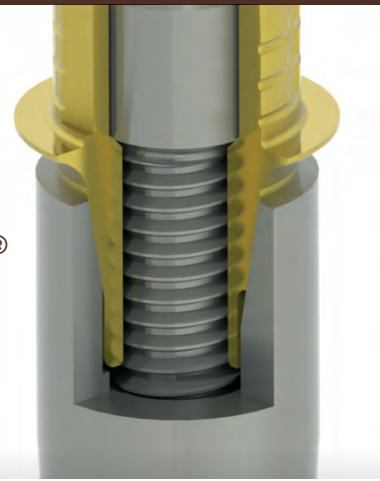

Ø3.5 / 3.75 / 4.0 / 4.3 / 5.0 / 6.0



AC 2G TiBase

Engaging
Non-Engaging

IBO 3601 620
IBO 3601 621



3G TiBase

Engaging H 1mm
Engaging H 2mm
Engaging H 3mm
Non-Engaging H 1mm
Non-Engaging H 2mm
Non-Engaging H 3mm

IBO 3601 601
IBO 3601 603
IBO 3601 605
IBO 3601 600
IBO 3601 602
IBO 3601 604



Multiunit Uniblock Abutment

H 0.8mm
H 1.5mm
H 2.5mm
H 3.5mm
H 4.5mm
H 5.5mm

IBO 3601 800
IBO 3601 801
IBO 3601 802
IBO 3601 803
IBO 3601 804
IBO 3601 805



Multiunit Angled Abutment

17° H 2.5 mm
17° H 3.5 mm
30° H 3.5 mm
30° H 4.5 mm

IBO 3601 852
IBO 3601 853
IBO 3601 863
IBO 3601 864



Lock-Attach Abutment

H 1mm
H 2mm
H 3mm
H 4mm

IBO 3601 901
IBO 3601 902
IBO 3601 903
IBO 3601 904

Ø3.5 / 3.75 / 4.0 / 4.3 / 5.0 / 6.0



Analogue

IBO 3601 300



Digital Analogue Screw

M1.6 w/hex. 1.20

HE-41215



Impression Coping

Open Tray (OT)

IBO 3601 350



Healing Cap

H 2mm
H 3.5mm
H 5mm

IBO 3601 402
IBO 3601 403
IBO 3601 405



Screw

M1.6 Neo

IBO 3601 200

M1.6 Four-Lobed ACS

IBO 3601 225



CoCr Base Castable

Engaging
Non-Engaging

IBO 3601 110
IBO 3601 100



Temporary Abutment

Engaging
Non-Engaging

IBO 3601 550
IBO 3601 555



Scanbody

Intraoral Titanium

IBO 3601 702

OSSTEM[®]

CAD/CAM 3000
TS SYSTEM[®]

Ibodontit S.L. has no connection with any of the brands listed above, which are the property of their respective trademark holders



Ground hedgehog spines at x20 zoom



OSSTEM® TS SYSTEM®

REGULAR

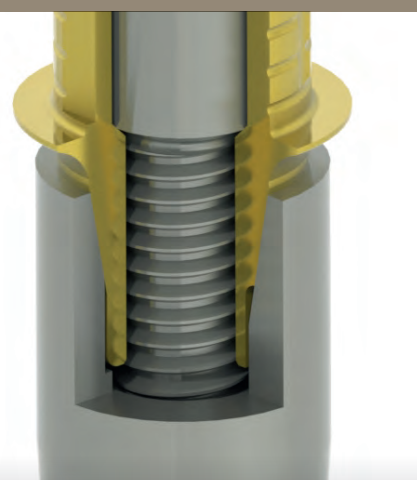

Ø3.5 / 3.75 / 4.0 / 4.3 / 5.0 / 6.0

AC 2G TiBase

Engaging
Non-Engaging

IBO 3601 620
IBO 3601 621

3G TiBase

Engaging H 1mm
Engaging H 2mm
Engaging H 3mm
Non-Engaging H 1mm
Non-Engaging H 2mm
Non-Engaging H 3mm

IBO 3601 601
IBO 3601 603
IBO 3601 605
IBO 3601 600
IBO 3601 602
IBO 3601 604

Multiunit Uniblock Abutment

H 0.8mm
H 1.5mm
H 2.5mm
H 3.5mm
H 4.5mm
H 5.5mm

IBO 3601 800
IBO 3601 801
IBO 3601 802
IBO 3601 803
IBO 3601 804
IBO 3601 805

Multiunit Angled Abutment

17° H 2.5 mm
17° H 3.5 mm
30° H 3.5 mm
30° H 4.5 mm

IBO 3601 852
IBO 3601 853
IBO 3601 863
IBO 3601 864

Lock-Attach Abutment

H 1mm
H 2mm
H 3mm
H 4mm

IBO 3601 901
IBO 3601 902
IBO 3601 903
IBO 3601 904

REGULAR

Analogue

IBO 3002 300

Digital Analogue Screw

M1.6 w/hex. 1.20

HE-41215

Impression Coping

Open Tray (OT)

IBO 3002 350

Healing Cap

H 2mm
H 4mm

IBO 3002 402
IBO 3002 404

Screw

M2 w/hex. 1.20

IBO 3002 200

M2 Four-Lobed ACS

IBO 3002 225

Castable

Engaging
Non-Engaging

IBO 3002 001
IBO 3002 010

CoCr Base Castable

Engaging
Non-Engaging

IBO 3002 110
IBO 3002 100

CoCr Base Angled Chimney

17°
25°

IBO 1102 011
IBO 1102 015

Scanbody

Intraoral Titanium
Laboratory Peek

IBO 3002 702
IBO 3002 700

BEGO[®]

CAD/CAM 3900
SC/RS[®]

Ibodontit S.L. has no connection with any of the brands listed above, which are the property of their respective trademark holders



Black truffle section at x150 zoom



BEGO[®]
SC/RS[®]

Ø3.25 / Ø3.75 / Ø4.1 / Ø4.5

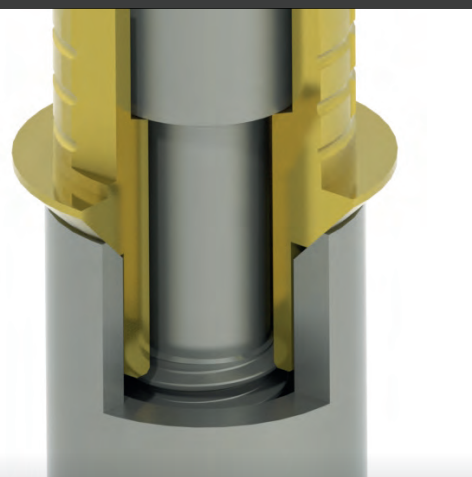

	Ø3.25 - 3.75	Ø4.1	Ø4.5
	Analogue		
	IBO 3901 300	IBO 3902 300	IBO 3903 300
	Digital Analogue Screw		
M1.6 w/hex. 1.20	HE-41215	HE-41215	HE-41215
	Impression Coping		
Open Tray (OT)	IBO 3901 350	IBO 3902 350	IBO 3903 350
	Healing Cap		
H 3mm	IBO 3901 403	IBO 3902 403	IBO 3903 403
H 5mm	IBO 3901 405	IBO 3902 405	IBO 3903 405
	Screw		
M1.8 w/hex. 1.25	IBO 3901 200	IBO 3901 200	IBO 3901 200
M1.8 Four-Lobed ACS	IBO 3901 225	IBO 3901 225	IBO 3901 225
	CoCr Base Castable		
Engaging	IBO 3901 110	IBO 3902 110	IBO 3903 110
Non-Engaging	IBO 3901 100	IBO 3902 100	IBO 3903 100
	CoCr Base Angled Chimney		
17°	IBO 1102 011	IBO 1102 011	IBO 1102 011
30°	IBO 1102 012	IBO 1102 012	IBO 1102 012
	Temporary Abutment		
Engaging	IBO 3901 550	IBO 3902 550	IBO 3903 550
Non-Engaging	IBO 3901 555	IBO 3902 555	IBO 3903 555

	Ø3.25 - 3.75	Ø4.1	Ø4.5
	Scanbody		
Intraoral Titanium	IBO 3901 702	IBO 3902 702	IBO 3903 702
	AC 2G TiBase		
Engaging	IBO 3901 620	IBO 3902 620	IBO 3903 620
Non-Engaging	IBO 3901 621	IBO 3902 621	IBO 3903 621
	3G TiBase		
Engaging H 0.5mm	IBO 3901 601	IBO 3902 601	IBO 3903 601
Engaging H 1.5mm	IBO 3901 603	IBO 3902 603	IBO 3903 603
Engaging H 2.5mm	IBO 3901 605	IBO 3902 605	IBO 3903 605
Non-Engaging H 0.5mm	IBO 3901 600	IBO 3902 600	IBO 3903 600
Non-Engaging H 1.5mm	IBO 3901 602	IBO 3902 602	IBO 3903 602
Non-Engaging H 2.5mm	IBO 3901 604	IBO 3902 604	IBO 3903 604
	Multiunit Uniblock Abutment		
H 1.5mm	IBO 3901 801	IBO 3902 801	IBO 3903 801
H 2.5mm	IBO 3901 802	IBO 3902 802	IBO 3903 802
H 3.5mm	IBO 3901 803	IBO 3902 803	IBO 3903 803
H 4.5mm	IBO 3901 804		
H 5.5mm	IBO 3901 805		
	Multiunit Angled Abutment		
17° H 2.5mm	IBO 3901 852	IBO 3902 852	IBO 3903 852
17° H 3.5mm	IBO 3901 853	IBO 3902 853	
30° H 3.5mm	IBO 3901 863	IBO 3902 863	IBO 3903 863
30° H 4.5mm	IBO 3901 864	IBO 3902 864	
	Lock-Attach Abutment		
H 1mm	IBO 3901 901	IBO 3902 901	IBO 3903 901
H 2mm	IBO 3901 902	IBO 3902 902	IBO 3903 902
H 3mm	IBO 3901 903	IBO 3902 903	IBO 3903 903
H 4mm	IBO 3901 904	IBO 3902 904	IBO 3903 904
H 5mm	IBO 3901 905		



Human eye nerve under light microscope x400

MEGAGEN[®]

CAD/CAM 3700
ANYRIDGE[®]

Ibodontit S.L. has no connection with any of the brands listed above, which are the property of their respective trademark holders



MEGAGEN® ANYRIDGE®

Ø4.0

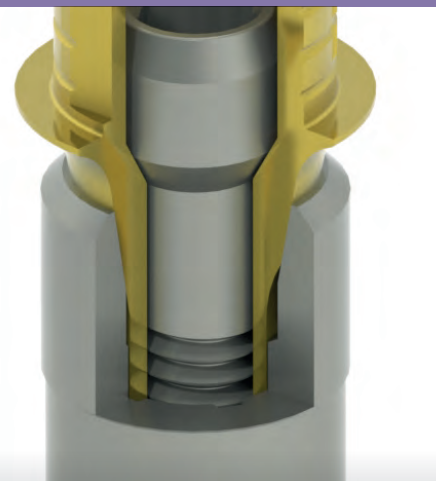

AC 2G TiBase

Engaging
Non-Engaging

IBO 3702 620
IBO 3702 621



3G TiBase

Engaging H 1mm
Engaging H 2mm
Engaging H 3mm
Non-Engaging H 1mm
Non-Engaging H 2mm
Non-Engaging H 3mm

IBO 3702 601
IBO 3702 603
IBO 3702 605
IBO 3702 600
IBO 3702 602
IBO 3702 604



Multiunit Uniblock Abutment

H 1.5mm
H 2.5mm
H 3.5mm
H 4.5mm

IBO 3702 801
IBO 3702 802
IBO 3702 803
IBO 3702 804



Multiunit Angled Abutment

17° H 2.5mm
17° H 3.5mm
30° H 3.5mm
30° H 4.5mm

IBO 3702 852
IBO 3702 853
IBO 3702 863
IBO 3702 864



Lock-Attach Abutment

H 1mm
H 2mm
H 3mm
H 4mm

IBO 3702 901
IBO 3702 902
IBO 3702 903
IBO 3702 904

Ø4.0



Analogue

IBO 3702 300



Digital Analogue Screw

M1.6 w/hex. 1.20

HE-41215



Impression Coping

Open Tray (OT)

IBO 3702 350



Healing Cap

H 2mm
H 4mm
H 6mm

IBO 3702 402
IBO 3702 404
IBO 3702 406



Screw

M1.8 w/hex. 1.20

IBO 3702 200

M1.8 Four-Lobed ACS

IBO 3702 225



CoCr Base Castable

Engaging
Non-Engaging

IBO 3702 110
IBO 3702 100



Temporary Abutment

Engaging
Non-Engaging

IBO 3702 550
IBO 3702 555



Scanbody

Intraoral Titanium

IBO 3702 702

INSTRUMENTATION



King kamchatka crab shell at x20 zoom



DRIVERS

DRIVER SET

8 Drivers + Handle for CLINICAL use



DRIVER SET

8 Drivers + Handle for LABORATORY use



DRIVER SET + TORQUE WRECH SET

6 Drivers + Adapter



DRIVER HANDLE

For CLINICAL use

IN-MAG1005



DRIVER HANDLE

For LABORATORY use

IN-MAG1006



TORQUE WRENCH

10 to 60 Ncm + Driver adapter

IN-LLV1003



HEAD DRIVER

	SHORT	MEDIUM	LONG	
HEX DRIVER 0.90	IN-DES1007	IN-DES1008	-	
HEX DRIVER 1.20	IN-DES1009	IN-DES1010	IN-DES1011	
HEX DRIVER 1.25	IN-DES1012	IN-DES1013	IN-DES1014	
HEX DRIVER 1.27	IN-DES1018	IN-DES1019	IN-DES1020	
HEX DRIVER 1.70	IN-DES1015	IN-DES1016	IN-DES1017	
FLAT-HEAD DRIVER	IN-DES1030	IN-DES1031	IN-DES1032	
ACS	ACS4L20	ACS4L25	ACS4L35	

HEAD DRIVER

	SHORT	MEDIUM	LONG	
SQUARE-HEAD DRIVER 1.25	IN-DES1033	IN-DES1034	IN-DES1035	
SQUARE-HEAD DRIVER 1.30	IN-DES1036	IN-DES1037	IN-DES1038	
CROSS-HEAD DRIVER	IN-DES1021	IN-DES1022	IN-DES1023	
UNIGRIP® DRIVER	IN-DES1024	IN-DES1025	IN-DES1026	
TORX DRIVER	IN-DES1027	IN-DES1028	IN-DES1029	

DRIVERS

	SHORT	LONG	
HEX DRIVER Hex 1.20	IN-DES1039	IN-DES1040	
HEX DRIVER Hex 1.25	IN-DES1041	IN-DES1042	
HEX DRIVER Hex 1.27	IN-DES1043	IN-DES1044	
TORX DRIVER	IN-DES1045	IN-DES1046	
UNIGRIP® DRIVER	IN-DES1047	IN-DES1048	



SURGICAL SET

Complete
IN-PLAS1



SURGICAL SET

Small
IN-PLAS2



FULL REMOVER SET

IN-KIT-EXT/L



UNIVERSAL GAUGE

008MB6



LOCK-ATTACH DRIVER

MANUAL SHORT
IN-LOC-MC

MANUAL LONG
IN-LOC-TC

COMPLETE
IN-LOC-O



SCREW REMOVER

Type 1
IN-EXT-1

Type 2
IN-EXT-2

Type 3
IN-EXT-3

Type 4
IN-EXT-4



IMPLANT REMOVER

SCREW REMOVER SET

External
680BR K

Internal
680CV

For screw remover set
680FS

For reaming
680FA25



C/A SHORT

IN-IHTC

C/A LONG

IN-IHTL



INTERNAL-HEX DRIVER

MANUAL SHORT

IN-IHCC

MANUAL LONG

IN-IHCL



REACTIVE DRIVER®

MANUAL SHORT 3.0

IN-ACMC

MANUAL LONG 3.0

IN-ACML



MANUAL SHORT 3.5

IN-ACMC35

MANUAL LONG 3.5

IN-ACML35

MANUAL SHORT 4.3

IN-ACMC43

MANUAL LONG 4.3

IN-ACML43



C/A SHORT 3.0

IN-ACTC

C/A LONG 3.0

IN-ACTL

C/A SHORT 3.5

IN-ACTC35

C/A LONG 3.5

IN-ACTL35

C/A SHORT 4.3

IN-ACTC43

C/A LONG 4.3

IN-ACTL43



SMARTGRIP DRIVER

MANUAL SHORT

IN-SGCS

MANUAL LONG

IN-SGDL



C/A SHORT

IN-SGDS

C/A LONG

IN-SGCL



MULTIUNIT DRIVER®

MANUAL SHORT 2.0

IN-MULMC 2.0

MANUAL LONG 2.5

IN-MULMC 2.5

MANUAL LONG 2.0

IN-MULML 2.0



MANUAL SHORT 2.5

IN-MULML 2.5

C/A 2.0

IN-MULT 2.0

C/A 2.5

IN-MULT 2.5

CONNECTOR

FOR 4x4 DRIVER

IN-ADC

FOR CONTRAANGLE

IN-IMDL



DIGITAL ADAPTER

FOR 4x4 DRIVER

IN-ADL



RATCHET

4X4 MM

IN-RW

EXTENSOR

IN-RE



HEX DRIVER 0.048" for RATCHET

SHORT

IN-THDC48

LONG

IN-THDL48

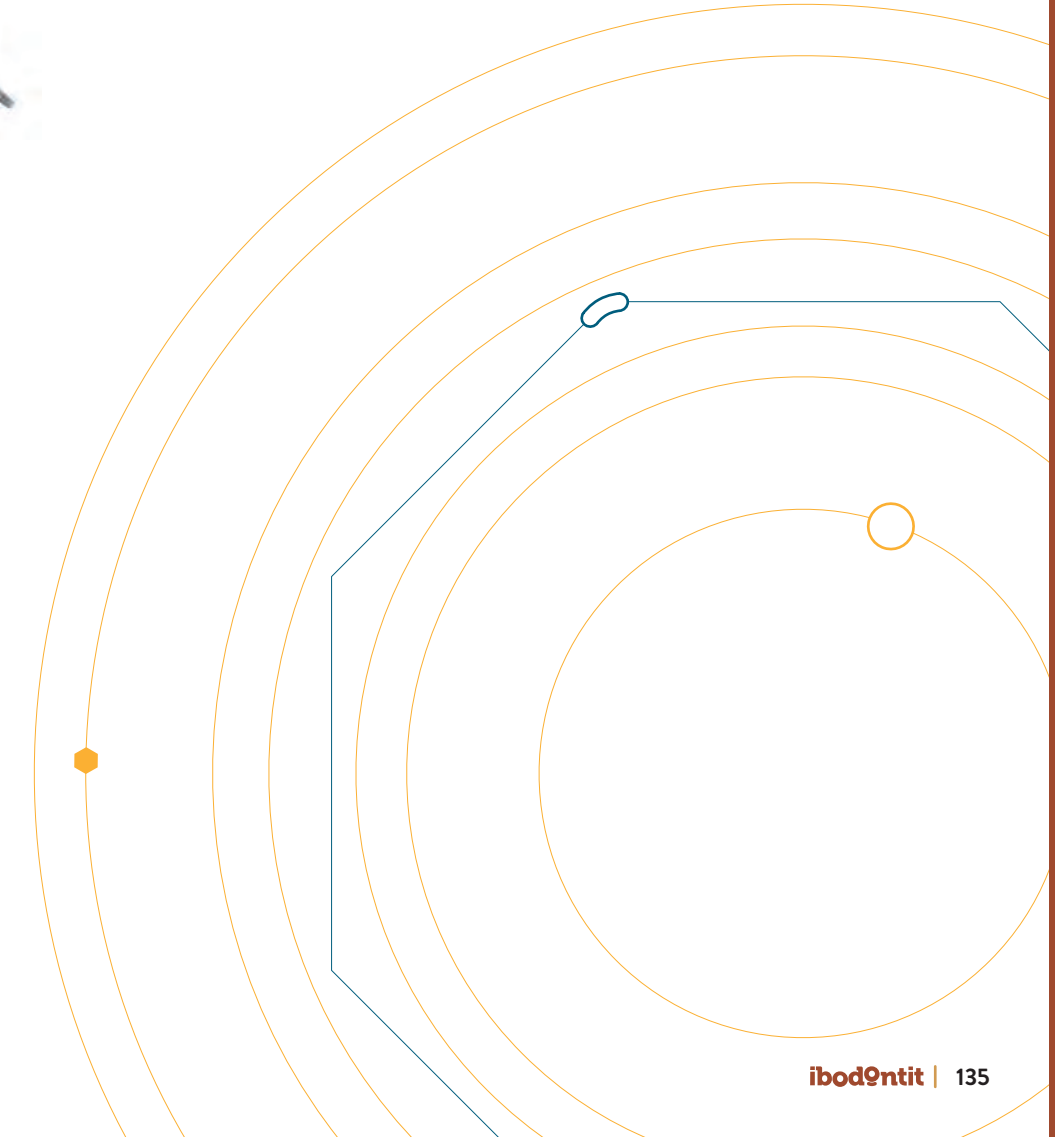



STRAIGHT ABUTMENT SCREWS

NOBEL BIOCARE®

PLATFORM	Reference	Seat	Driver	Ø Head	Length	Thread	Torque
BRANEMARK® NP	HE-35200	70	Unigrip®	2.2	7.3	M1.6	35
BRANEMARK® NP	HE-35280	70	Unigrip®	2.2	7.3	M1.6	35
BRANEMARK® RP	HE-41200	90	Hex 1.27	2.4	7.9	M2	25
BRANEMARK® RP	HE-41280	90	Hex 1.27	2.4	7.9	M2	25
BRANEMARK® RP	HE-41201	Flat	Hex 1.20	2.5	8.8	M2	25
BRANEMARK® RP	HE-41202	90	Cuad 1.30	2.4	7.9	M2	25
BRANEMARK® RP	HE-41203	90	Hex 1.25	2.45	7.9	M2	25
BRANEMARK® RP	HE-41204	120	Hex 1.20	2.4	6.5	M2	25
BRANEMARK® RP	HE-41205	120 self-locking	Hex 1.25	2.45	8	M2	25
BRANEMARK® RP	HE-41206	90	Hex 1.20	2.4	7.9	M2	25
BRANEMARK® RP	HE-41207	90	Unigrip®	2.4	7.9	M2	25
BRANEMARK® RP	HE-41208	90	Hex 1.20	2.45	7.9	M2	35
MULTIUNIT®	HE-48200	Flat	Unigrip®	2	3.5	M1.4	15
MULTIUNIT®	HE-48280	Flat	Unigrip®	2	3.5	M1.4	15
MULTIUNIT®	HE-48206	Flat	Unigrip®	2	3.5	M1.4	15
MULTIUNIT®	HE-48201	Flat	hex 1,27	2	3.5	M1.4	15
BRANEMARK® WP	HE-51200	90	Hex 1.20	3.3	7	M2.5	35
BRANEMARK® WP	HE-51280	90	Hex 1.20	3.3	7	M2.5	35
REPLACE SELECT® 3.5	HEZ-35200	Flat	Unigrip®	2.4	8.3	M1.8	35
REPLACE SELECT® 4.3 / 5,0	HEZ-43200	Flat	Unigrip®	2.4	9.9	M2	35
ACTIVE 3.0	HEC-30200	110	Hex 1.20	1.82	7	M1.4	15
ACTIVE® NP	HE-35200	70	Unigrip®	2.2	7.3	M1.6	35
ACTIVE® NP	HE-35280	70	Unigrip®	2.2	7.3	M1.6	35
ACTIVE® NP	HEC-35206	70	Unigrip®	2.2	7.3	M1.6	35
ACTIVE® RP	HEC-43200	70	Unigrip®	2.45	7.35	M2	35
ACTIVE® RP	HEC-43280	70	Unigrip®	2.45	7.35	M2	35
ACTIVE® RP	HEC-43206	70	Unigrip®	2.45	7.35	M2	35

ZIMMER®

PLATFORM	Reference	Seat	Driver	Ø Head	Length	Thread	Torque
HEX. INTERNO NP	HEI-35200	90	Hex 1.20	2.1	8.2	M1.8	30
HEX. INTERNO NP / RP / WP	HEI-35201	140	Hex 1.27	1.98	8	UNF1-72	30
HEX. INTERNO NP / RP / WP	HEI-35280	140	Hex 1.27	1.98	8	UNF1-72	30
HEX. INTERNO NP / RP / WP	HEI-35205	120	Hex 1.25	2.1	7.65	M1.8	30
HEX. INTERNO NP / RP / WP	HEI-35206	140	Hex 1.27	1.98	8	UNF1-72	30

STRAUMANN®

PLATFORM	Reference	Seat	Driver	Ø Head	Length	Thread	Torque
TISSUE LEVEL RN	HI-48200	90	Torx	2.4	7.5	M2	35
TISSUE LEVEL RN	HI-48205	120 self-locking	Hex 1.205	2.47	8.03	M2	25
TISSUE LEVEL RN SYNOCTA	HI-48201	90	Torx	2.4	4.5	M2	35
TISSUE LEVEL RN / WN	HI-48206	30	Torx	2.58	6.7	M2	35
TISSUE LEVEL RN / WN	HI-48204	30	Torx	2.58	6.7	M2	35
TISSUE LEVEL RN / WN	HI-48280	30	Torx	2.58	6.7	M2	35
BONE LEVEL NC	HI-33200	30	Torx	2.08	7.9	M1.6	35

BONE LEVEL NC	HI-33206	30	Torx	2.08	7.9	M1.6	35
BONE LEVEL NC	HI-33280	30	Torx	2.08	7.9	M1.6	35
BONE LEVEL RC	HI-41200	30	Torx	2.2	7.85	M1.6	35
BONE LEVEL RC	HI-41206	30	Torx	2.2	7.85	M1.6	35
BONE LEVEL RC	HI-41280	30	Torx	2.2	7.85	M1.6	35
BLX 3,5 / 4,5	IBO 3801 200	90	Torx	2,1	6,1	M1.6	30

ASTRA®

PLATFORM	Reference	Seat	Driver	Ø Head	Length	Thread	Torque
OSSEOSPEED TX 3.0	IBO 2003 200	Flat	Hex 1.27	2.35	7.3	M1.4	15
OSSEOSPEED TX 3.5-4.0	HEA-35200	Flat	Hex 1.27	2.35	8.25	M1.6	20
OSSEOSPEED TX 3.5-4.0	HEA-35280	Flat	Hex 1.27	2.35	8.25	M1.6	20
OSSEOSPEED TX 4.5-5.0	HEA-45200	Flat	Hex 1.27	2.35	10.3	M2	25
UNIABUTMENT® 20°	HEA-35201	Flat	Hex 1.27	2.25	4.8	M1.4	15
EV® 3.0	IBO 3201 200	60	Hex 1.27	2.1	7.3	M1.4	20
EV® 3.6	IBO 3202 200	60	Hex 1.27	2.1	7.3	M1.6	20
EV® 4.2	IBO 3203 200	100	Hex 1.27	2.1	10.3	M1.8	20
EV® 4.8	IBO 3204 200	Flat	Hex 1.27	2,3	7,6	M2	20

BIOMET 3i®

PLATFORM	Reference	Seat	Driver	Ø Head	Length	Thread	Torque
CERTAIN® NP / RP / WP	HEW-34200	Flat	Hex 1.20	2	8.4	M1.6	20
CERTAIN® NP / RP / WP	HEW-34280	Flat	Hex 1.20	2	8.4	M1.6	20
CERTAIN® NP / RP / WP	HEW-34201	90	Hex 1.20	2.27	8.4	M1.6	20
CERTAIN® NP / RP / WP	HEW-34206	Flat	Hex 1.20	2	8.4	M1.6	20
CERTAIN® RP / WP	HEW-41201	90	Hex 1.20	2,3	8,4	M1.6	20
CERTAIN® RP / WP	HEW-41206	90	Hex 1.20	2,3	8,4	M1.6	20
CERTAIN® RP / WP	HEW-41280	90	Hex 1.20	2,3	8,4	M1.6	20
OSSEOTITE® 3,25	IBO 2101 200	Flat	Hex 1.2	2.3	7.5	M1.6	20
OSSEOTITE® 4,1	HE-41200	90	Hex 1.27	2.4	7.9	M2	25
OSSEOTITE® 4,1	HE-41280	90	Hex 1.27	2.4	7.9	M2	25
OSSEOTITE® 5.1	HE-41200	90	Hex 1.27	2.4	7.9	M2	25

KLOCKNER®

PLATFORM	Reference	Seat	Driver	Ø Head	Length	Thread	Torque
SK2® 4.2	HEV-42200	90	Hex 1.70	2.45	6	M1.8	30
SK2® 4.2	HEV-42201	90	Crosshead	2,3	4,4	M1.8	30
ESSENTIAL CONE® 4.5	HEV-45200	90	Star-head	2.15	8.2	UNF1-72	30
VEGA 3,5	IBO 4101 200	90	Star-head	2,43	8	M1,6	25
VEGA 4,0-4,5	IBO 4102 200	90	Star-head	2,32	8	M1,6	25



STRAIGHT ABUTMENT SCREWS

BTI®

PLATFORM	Reference	Seat	Driver	Ø Head	Length	Thread	Torque
EXTERNAL HEX. 3,5	HEB-35200	Flat	Hex 1.20	2,57	5,5	M2	20
EXTERNAL HEX. 4,1	HE-41200	90	Hex 1.27	2,4	7,9	M2	25
EXTERNAL HEX. 3,5 / 4,1	HE-41280	90	Hex 1.27	2,4	7,9	M2	25
UNIVERSAL INT. 4.1 / 5,5	HEB-41200	Flat	Hex 1.20	2,5	7	M1.8	20
UNIVERSAL INT. 4.1 / 5,5	HEB-41206	Flat	Hex 1.20	2,5	7	M1.8	20
UNIVERSAL INT. 4.1 / 5,5	HEB-41280	Flat	Hex 1.20	2,5	7	M1.8	20
UNIVERSAL INT. 4.1 MULTI	HEB-41208	Flat	Hex 1.20	2	3,6	M1.8	20

MIS®

PLATFORM	Reference	Seat	Driver	Ø Head	Length	Thread	Torque
SEVEN NP	HEM-33200	120	Hex 1.27	2,1	7,6	M1,6	30
SEVEN NP	HEM-33280	120	Hex 1.27	2,1	7,6	M1,6	30
SEVEN SP / WP	HEM-42200	120	Hex 1.27	2,2	7,6	M1,8	30
C1 STANDARD 3,75 / 4,2	IBO 4002 200	120	Hex 1.27	2,2	7,6	M1,8	30

SWEDEN&MARTINA®

PLATFORM	Reference	Seat	Driver	Ø Head	Length	Thread	Torque
PREMIUM KHONO® 3,3 / 3,8	HES-38200	120	Hex 1.27	2,15	7,45	M1,8	25
PREMIUM KHONO® 3,3 / 3,8	HES-38280	120	Hex 1.27	2,15	7,45	M1,8	25
PREMIUM KHONO® 4,25 / 5,0	HES-43200	120	Hex 1.27	2,5	8,1	M2	25
PREMIUM KHONO® 4,25 / 5,0	HES-43280	120	Hex 1.27	2,5	8,1	M2	25

DENTSPLY®

PLATFORM	Reference	Seat	Driver	Ø Head	Length	Thread	Torque
FRIADENT XIVE® 3,4 / 3,8 / 4,5	IBO 3102 200	90	Hex 1.20	2	8	M1,6	25
FRIADENT XIVE® 3,4 / 3,8 / 4,5	IBO 3102 280	90	Hex 1.20	2	8	M1,6	25

BIOHORIZONS®

PLATFORM	Reference	Seat	Driver	Ø Head	Length	Thread	Torque
INTERNAL 3.0	IBO 1601 200	90	Hex 1.27	1,8	8,2	M1,4	15
INTERNAL 3,5 / 4,5	HEI-35201	140	Hex 1.27	1,98	8	UNF1-72	30
INTERNAL 3,5 / 4,5	HEI-35280	140	Hex 1.27	1,98	8	UNF1-72	30

MICRODENT®

PLATFORM	Reference	Seat	Driver	Ø Head	Length	Thread	Torque
EXTERNAL HEX. SYSTEM® 4,2 / 5,1	HE41200	90	Hex 1.27	2,4	7,9	M2	25
EXTERNAL HEX. SYSTEM® 4,2 / 5,1	IBO 3302 201	Flat	Hex 1.75	2,4	7,9	M2	30

OSSTEM®

PLATFORM	Reference	Seat	Driver	Ø Head	Length	Thread	Torque
TS SYSTEM® REGULAR	IBO 3002 200	90	Hex 1.20	2,3	8,4	M2	25

NEODENT®

PLATFORM	Reference	Seat	Driver	Ø Head	Length	Thread	Torque
CM®	IBO 3402 200	Flat	Hex 0.90	2,4	7,9	M1,8	25
CM®	IBO 3402 280	Flat	Hex 0.90	2,4	7,9	M1,8	25
GRAND MORSE	IBO 3601 200	60	Unigrip	1,86	9,77	M1,6	20

ANKYLOS®

PLATFORM	Reference	Seat	Driver	Ø Head	Length	Thread	Torque
C/X®	IBO 3502 200	90	Hex 0.90	2,4	7,9	M1,8	20

PHIBO®

PLATFORM	Reference	Seat	Driver	Ø Head	Length	Thread	Torque
EXTERNAL HEX. 3,3	HPH-33200	120	Hex 1,27	2,25	8	M1,8	25
EXTERNAL HEX. 4,2	HE-41200	90	Hex 1.27	2,4	7,9	M2	25
EXTERNAL HEX. 4,2	HE-41280	90	Hex 1.27	2,4	7,9	M2	25
EXTERNAL HEX. 4,2	HE-41203	90	Hex 1.25	2,45	7,9	M2	25

BEGO SEMADOS®

PLATFORM	Reference	Seat	Driver	Ø Head	Length	Thread	Torque
3,25-3,75 / 4,1 / 4,5	IBO 3901 200	70	Hex. 1,25	2,35	7,68	M1,8	30

MEGAGEN ANYRIDGE®

PLATFORM	Reference	Seat	Driver	Ø Head	Length	Thread	Torque
4,0 / 4,5	IBO 3702 200	Flat	Hex.1,2	2,1	8	M1,8	25



ANGLED ABUTMENT SCREWS

NOBEL BIOCARE®

PLATFORM	Reference	Seat	Driver	Ø Head	Length	Thread	Torque
BRANEMARK® NP	IBO 1101 225	Flat	ACS	2.3	5.9	M1.6	20
BRANEMARK® RP	IBO 1102 225	Flat	ACS	2.3	6	M2	25
BRANEMARK® WP	IBO 1103 225	Flat	ACS	2.85	6.7	M2.5	25
MULTIUNIT®	IBO 1201 225	Flat	ACS	2.4	3.9	M1.4	15
REPLACE SELECT® 3.5	IBO 1301 225	Flat	ACS	2.3	7.5	M1.8	20
REPLACE SELECT® 4.3	IBO 1302 225	Flat	ACS	2.3	9	M2	25
ACTIVE® NP	IBO 1401 225	70	ACS	2.3	7.3	M1.6	15
ACTIVE® RP	IBO 1402 225	70	ACS	2.3	7.5	M2	20

ZIMMER®

PLATFORM	Reference	Seat	Driver	Ø Head	Length	Thread	Torque
INTERNAL HEX. NP / RP / WP	IBO 1501 225	140	ACS	2.3	7.1	M1.8	20

STRAUMANN®

PLATFORM	Reference	Seat	Driver	Ø Head	Length	Thread	Torque
TISSUE LEVEL RN / WN	IBO 1801 225	30	ACS	2.6	6.7	M2	25
TISSUE LEVEL RN SYNOCTA	IBO 1801 226	90	ACS	2.3	5.1	M2	25
BONE LEVEL NC / RC	IBO 1902 225	30	ACS	2.3	7.8	M1.6	15
BLX RB / WB	IBO 3801 225	90	ACS	2,3	6,1	M1,6	30

ASTRA®

PLATFORM	Reference	Seat	Driver	Ø Head	Length	Thread	Torque
OSSEOSPEED TX 3.5-4.0	IBO 2001 225	Flat	ACS	2.3	7.6	M1.6	20
OSSEOSPEED TX 4.5-5.0	IBO 1302 225	Flat	ACS	2.3	9	M2	25
EV® 3.0	IBO 3201 225	60	ACS	2.3	7.3	M1.4	15
EV® 3.6	IBO 3202 225	60	ACS	2.3	7.2	M1.6	20
EV® 4.2	IBO 3203 225	100	ACS	2.3	7.4	M1.8	20
EV® 4.8	IBO 3204 225	Flat	ACS	2,3	7,6	M1,8	20

BIOMET 3i®

PLATFORM	Reference	Seat	Driver	Ø Head	Length	Thread	Torque
CERTAIN® NP / RP / WP	IBO 2201 225	Flat	ACS	2.3	6	M2	25
OSSEOTITE®	IBO 1102 225	Flat	ACS	2.3	6	M2	25

KLOCKNER®

PLATFORM	Reference	Seat	Driver	Ø Head	Length	Thread	Torque
SK2® 4.2	IBO 2301 225	90	ACS	2.3	4.5	M1.8	20
ESSENTIAL CONE® 4.5	IBO 2401 225	90	ACS	2.3	6.7	M1.8	20
VEGA 3,5	IBO 4101 225	90	ACS	2,3	8	M1,8	20
VEGA 4,0-4,5	IBO 4102 225	90	ACS	2,3	8	M1,8	20

BTI®

PLATFORM	Reference	Seat	Driver	Ø Head	Length	Thread	Torque
EXTERNAL HEX. 3.5 / 4,1	IBO 1102 225	Flat	ACS	2.3	6	M2	25
UNIVERSAL INT. 4.1 / 5,5	IBO 2501 225	Flat	ACS	2.3	6.5	M1.8	20
UNIVERSAL INT. 4.1 MULTI	IBO 2501 226	Flat	ACS	2,3	3,6	M1,8	20

MIS®

PLATFORM	Reference	Seat	Driver	Ø Head	Length	Thread	Torque
SEVEN NP	IBO 1701 225	120	ACS	2.3	6.45	M1.6	20
SEVEN SP / WP	IBO 1501 225	140	ACS	2.3	7.1	M1.8	20
C1 STANDARD 3,75 / 4,2	IBO 1501 225	140	ACS	2.3	7.1	M1.8	20

SWEDEN&MARTINA®

PLATFORM	Reference	Seat	Driver	Ø Head	Length	Thread	Torque
PREMIUM KHONO 3.3 / 3,8	IBO 2702 225	120	ACS	2.3	6.8	M1.8	20
PREMIUM KHONO 4.25 / 5,0	IBO 2703 225	120	ACS	2.3	6.8	M2	25

DENTSPLY®

PLATFORM	Reference	Seat	Driver	Ø Head	Length	Thread	Torque
FRIADENT XIVE® 3.4 / 3,8 / 4,5	IBO 3102 225	90	ACS	2.3	8	M1.6	20

MICRODENT®

PLATFORM	Reference	Seat	Driver	Ø Head	Length	Thread	Torque
EXTERNAL HEX. SYSTEM® 4.2	IBO 1102 225	Flat	ACS	2.3	6	M2	25
EXTERNAL HEX. SYSTEM® 5.1	IBO 1102 225	Flat	ACS	2.3	6	M2	25

OSSTEM®

PLATFORM	Reference	Seat	Driver	Ø Head	Length	Thread	Torque
TS SYSTEM® REGULAR	IBO 3002 225	90	ACS	2.3	7.9	M2	25

NEODENT®

PLATFORM	Reference	Seat	Driver	Ø Head	Length	Thread	Torque
CM®	IBO 3402 225	60	ACS	2.3	4	M1.4	15
GRAND MORSE	IBO 3601 225	60	Unigrip	2,3	9,77	M1,6	20

ANKYLOS®

PLATFORM	Reference	Seat	Driver	Ø Head	Length	Thread	Torque
C/X®	IBO 3502 225	Flat	ACS	2.3	4.4	M1.6	20



ANGLED ABUTMENT SCREWS

PHIBO®

PLATFORM	Reference	Seat	Driver	Ø Head	Length	Thread	Torque
EXTERNAL HEX. 3,3	IBO 2901 225	120	ACS	2,3	8	M1,8	25
EXTERNAL HEX. 4,1	IBO 1102 225	Flat	ACS	2,3	6	M2	25

BEGO SEMADOS®

PLATFORM	Reference	Seat	Driver	Ø Head	Length	Thread	Torque
3,25-3,75 / 4,1 / 4,5	IBO 3901 225	70	ACS	2,3	7,7	M1,8	30

MEGAGEN ANYRIDGE®

PLATFORM	Reference	Seat	Driver	Ø Head	Length	Thread	Torque
3,25-3,75 / 4,1 / 4,5	IBO 3702 225	Flat	ACS	2,3	8	M1,8	25

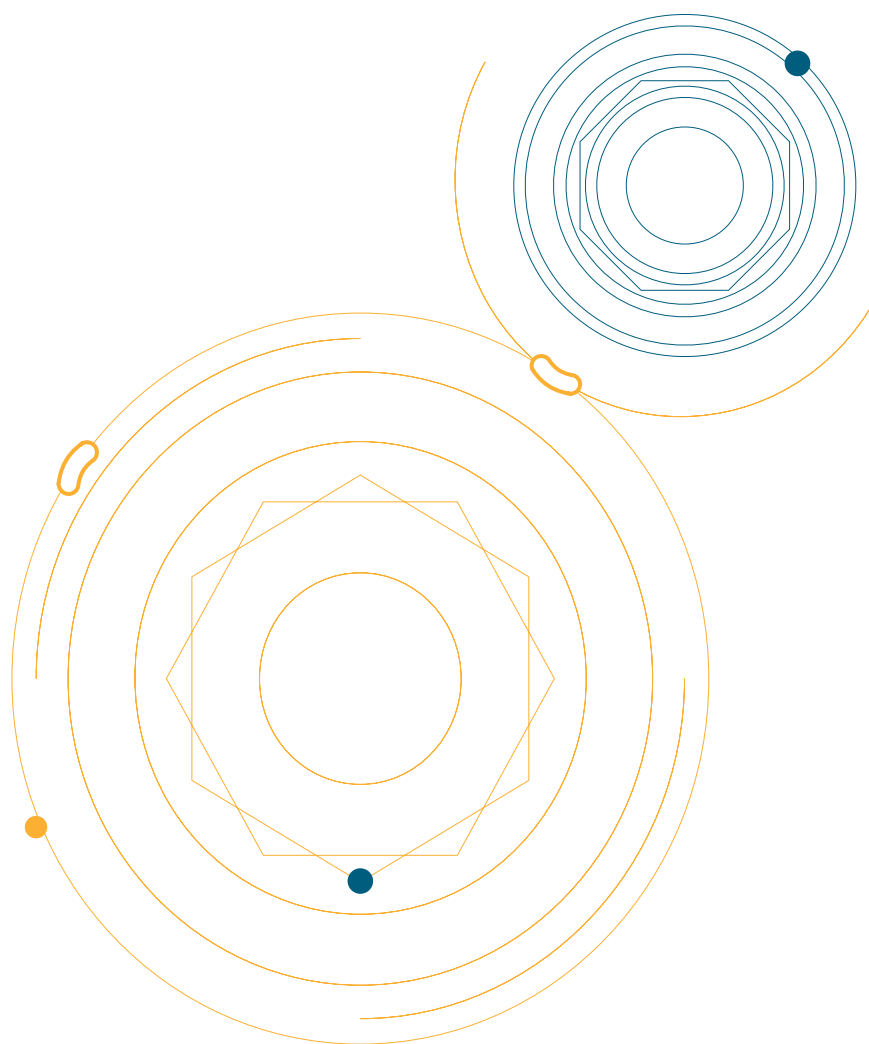

ABUTMENTS CATALOGUE 2022

1st Revision: 02/2022

Authorised by IBO





www.ibodontit.com
ventas@ibodontit.com
